

QUALITY & INNOVATION

Equipment for functional training made in Europe.

Technically advanced, reliable and resistant, with the possibility of customization. Years of research, development and design experience have resulted in KingsBox being one of Europe's best-known functional equipment suppliers.

All products are manufactured with the help of modern technology: laser-cut and welded with robotic welding and CNC lathes to guarantee maximum precision and thus achieving high quality.

High quality and attention to details

The quality of the equipment is apparent not only in the refined look but also in the reliability, safety and convenient use of the modular properties. The training tools have been designed and built to withstand all training conditions and last a lifetime.

Certificates and materials

Only certified materials are used for the manufacturing of our products, as well as qualified and specialized personnel, as required by European regulations. Because of the close collaboration of the design and the production team it is possible to combine quality, functionality and refined design in every one of our products.

KingsBox general warranty

We offer different warranty periods on our products ranging from a standard 2-year warranty up to a lifetime warranty. Contact us for more information.

DELIVERY & SHIPPING

Shipping time

The goods will be shipped to customers in the shortest possible time, although usually the goods are shipped to customers within 24-48 hours (working days) of the confirmation of the order.

Courier

Shipments are carried out by the following shipping companies: BRT, Ceccarelli, Arco Spedizioni, GLS, and in some cases by private couriers.

Delivery method

Delivery is made within 24-48 hours of the shipment. The package will be delivered to the address provided by the customer during the ordering process.

METHODS OF PAYMENT

KingsBox's shop offers the following payment methods:

- Cash on delivery (only in cash, up to a maximum limit of €2990)
- Bank transfer to the account of TNG Oprema d.o.o.
- PayPal (info@kingsbox.it)
- ATM card or credit card
- Leasing (Grenke Leasing)

CONTENT

RIG & RACKS	5
ABOUT OUR RIGS & RACKS	7
CUSTOM RIGS & RACKS	9
FREESTANDING RIGS	11
WALL RIGS	13
RACKS	15
OUTDOOR RIGS & RACKS	23
OUTDOOR ACCESSORIES	28
ONE PERSON GYM SET	29
ACCESSORIES FOR RIGS & RACKS	31
JAMMER ARMS	37
COLUMNS & COLUMNS EXTENSION	41
PULL UP BARS & PEGBOARD	43
KINGSBOX CLOSET GYM	45
MAD SERIES MACHINES	47
MIGHTY SPS	51
STRENGTH MACHINES	53
BARS & PLATES	57
CERAKOTE	59
BARS	61
PLATES	71
PROPS & ACCESSORIES	75
DUMBBELLS	78
KETTLEBELLS	81
BALLS	83
SANDBAGS & STONES	84

PLYO BOX & JERK BLOCKS	85
VESTS	89
JUMP ROPES	91
SUSPENSION TRAINING & ROPES	93
MATS	97
PARALLETES	98
CLUBBELLS & HAMMERS	99
HURDLES	100
BENCHES	103
SLEDS & GHDS	109
REVERSE HYPER	111
YOKE AND CARRY GEAR	113
CARDIO MACHINES	117
STORAGE	119
TIMERS	123
WHITEBOARDS & FURNITURE	124
FLOORING	125
MOBILITY	127
ACCESSORIES	129
GRIP	131
CLOTHING	135
CUSTOM APPAREL	149
OTHER APPAREL	151
KIDS EQUIPMENT	153

SPECIALS

WE ARE KINGSBOX	3
ONE PERSON GYM SET	29
KINGSBOX CLOSET GYM	45
MAD SERIES MACHINES	47
MIGHTY SPS	51
ROYAL FAMILY	101
KINGSBOX ATHLETE	133
CUSTOM APPAREL	149



KingsBox
EQUIPPED BY

CUSTOMER SERVICE

MO - FRI 8:00 - 16:00

Telephone:
+386 30 351 866

E-mail:
info@kingsbox.it



Visit us on **facebook** at
facebook.com/kingsbox



Visit us on **instagram** at
[@kingsbox](https://instagram.com/kingsbox)

OUR MISSION:

Giving people a playground to develop into the best version of themselves.
Delivering products that inspire masses in the gym industry.

OUR VISION:

A world where every single one of us is equipped to reach their full potential.

WHO WE ARE?



2015

Born in a garage

Our story began when two friends – Dejan And Luka started making equipment in their garage. In only 7 years it grew into one of the largest providers of sport equipment in Europe and a company with more than 60 employees! Since the beginning, our main values are developing people's full potential and making new innovative products. And we are not stopping!

VALUES:

We are always looking for opportunities for growth, for improvements and innovations, so this are the values that represent us best.

**Driven by innovation.
Devoted to growth.
Going the extra mile.**

RIGS & RACKS



ABOUT OUR RIGS & RACKS

HOME SERIES 50 X 50 MM PROFILE



ROYAL SERIES 60 X 60 MM PROFILE



MIGHTY SERIES 80 X 80 MM PROFILE



The third series, which was presented only two years ago, is the Home Series made from 50X50X3mm profiles, available for racks only. This series is dedicated to home gym owners. With the user's budget in mind we kept the design simple and rather focused on functionality and quality.

All our racks and rigs are completely modular, meaning that as you grow, the gym grows with you too.

Technically advanced, reliable and resistant, with the possibility of customization. Years of research, development and design experience have resulted in KingsBox being one of Europe's best-known functional equipment suppliers.

All Rigs and Racks are manufactured with the help of modern technology in order to guarantee maximum precision and high quality.

KingsBox Rigs and Racks are made in Europe (Slovenia). All the equipment in the design phase goes through the prototyping phase, which usually takes a few months to complete.

Once the product has been defined, it is firstly tested by our technical staff and then sent to our best athletes, who assess the product while remaining objective in the evaluation. Thanks to them we can strive for the continuous improvement of all our tools. The last step is putting the product into serial production and for sale.

The quality of the products and the notion of being able to offer one of the best services in the field is not just a written idea for advertising purposes, but primarily a fact and a promise, which we are committed to keeping on a daily basis.

All products have a warranty period, during which the item can be replaced or returned.

Our hot zinc plated rigs and racks are made for outdoor use, so you can even mount them at the beach, in your back yard or on the parking lot in front of your gym without worrying about weather conditions. Sunshine, rain, snow, or a tornado – worry about your house and your safety, but certainly do not worry about our Rigs or Racks. You can choose between a range of colors: Gold, Red, Blue, Green, Yellow, Orange, Grey, White, or Black.

Grip

We usually get the best suggestions for improvements when talking to athletes who use our equipment. Three years ago, in one of our first competitions, we talked with some athletes and we found out that they all had a similar problem - a bad grip on the pull up bars of the rig. It might sound like a small problem, but actually it was something that got in the way when they tried to show their full potential in competitions. So we returned home, and were determined to create a perfect coating for our pull up bars. One that offers a firm grip even without a large amount of magnesium, while at the same time is not too rough on the skin of one's palms. After months of researching and testing 138 different color samples and working with 29 color manufacturers, we discovered the right grip in 2016. We call it simply: KingsBox® Grip.

Today, this is one of the main reasons why more and more trainers are demanding KingsBox Rig for their gym or competition.

You can choose between 9 different standard colors: Gold, Red, Blue, Green, Yellow, Orange, Grey, White or Black.

Certificates

All our products are made exclusively from certified materials by a qualified and specialized personnel, as required by European regulations. Because of the close collaboration of the design and the production team it is possible to combine quality, functionality and refined design in every one of our products.

The Mighty series is made from 80X80X3 mm profiles and is designed to be our top-tier, maxed-out option for high-performance strength training.

All Mighty uprights have holes with laser-cut number markings, so you can quickly adjust the height of J cups, Angel arms, and 40 other Mighty accessories compatible with this series.

Our more economical series is the Royal series made from 60X60X3 mm profiles. This series is dedicated to those who want a more budget-friendly solution, but do not want to lose any functionality and quality. With number markings on every 5th hole, you can easily remember the perfect height for your back squats or bench press from the last training. This series is compatible with more than 20 different accessories such as Dip Bars, Angel Arms, Startup bars...



CUSTOM RIGS & RACKS

LOOKING FOR A STEEL CONSTRUCTION THAT WILL CREATE NEW TRAINING POSSIBILITIES?

Our designs can be adapted to your desires and training style. Of course, you will also be provided with tips and advice to make sure you choose the construction that best fits your needs. Why are the KingsBox constructions your best choice? The answer is because they can be fully custom-made!

The sky is the limit when it comes to designing and developing new structures. We are aware of the fact that many of our clients have problems with concrete pillars in the middle of the training area or drywalls that are not mountable, but that should not be a reason to panic. We have many existing solutions for such issues, but we can take problems on unknown grounds as well.

Let us know about your ideas and we will make them happen – first on paper with a 3D render, and if you are satisfied with the outcome, also with a realization of your Rig.

For more information, please write us on info@kingsbox.it.

IT'S VERY SIMPLE: WHEN
A CLIENT HAS A PROBLEM,
WE SOLVE IT.



Available upon order: info@kingsbox.it

FREESTANDING RIGS

CHOOSE YOUR SIZE FROM 2 TO ∞ COLUMNS



FREESTANDING MONKEY RIG
MIGHTY OR ROYAL



01 Freestanding Rig I Mighty or Royal · **02 Freestanding Monkey Wall Rig I** Mighty or Royal I · **03 Mighty Strength corner I** Article no: KB04MI-023-02 · **04 Mighty Double CX-35 I** Article no: KB-04MI-024-02 · **05 Mighty Functional Station I** Article no: KB-04MI-026-02 · **06 Mighty Monkey Arch I** Article no: KB03MI-011-02 · **07 Mighty Fortress I** Article no: KB04MI-025-03

WALL RIGS

01



WALL RIG
MIGHTY OR ROYAL

01 Wall Rig | Mighty or Royal - 02 Mon-
key Wall Rig | Mighty or Royal - 03
Mighty on the Wall WR-6 | Article no:
KB02MI-012-02

03



MIGHTY ON THE WALL WR-6

WALL MONKEY RIG
MIGHTY OR ROYAL

02



RACKS



HOME RACKS 50 X 50 MM PROFILE

01 Home Adjustable rack AS-5 | Adjustable height (92–180 cm), Profile size: 50 x 50 cm | Article no: X-063-1000 · **02 Home Squat rack SS-5** | Profile size: 50 x 50 cm | Article no: X-063-1100 · **03 Home Squat rack SS-10** | Profile size: 50 x 50 cm | Article no: X-063-2100



ROYAL RACKS 60 X 60 MM PROFILE



04 Royal Squat Rack SX-5 II. | Article no: KB04RI-007 · **05 Royal Squat Rack SX-10 II.** | Article no: KB04RI-008 · **06 Royal Squat Rack SX-15 II.** | Profile size: 50 x 50 cm | Article no: KB04RI-009 · **07 Royal Squat Rack SX-20** | Article no: KB04RI-013 · **08 Royal Squat Rack SX-25** | Article no: KB04RI-017





01

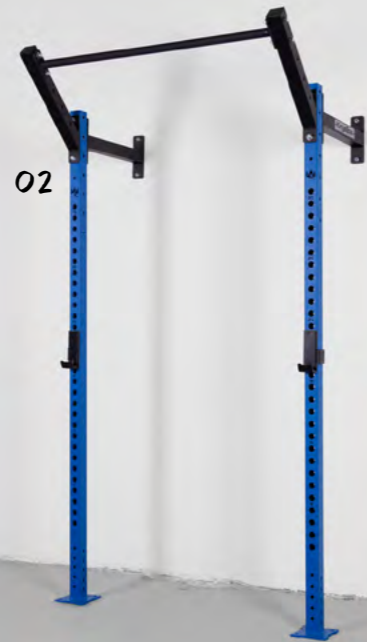

02



03

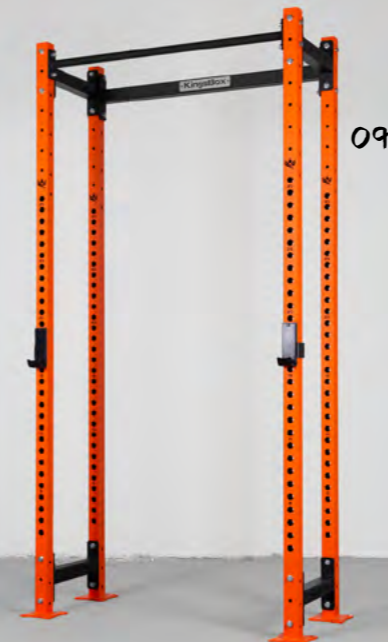

09



10



04

01 Royal Wall Power Rack II. 300
 | Article no: KB02RI-011 · **02 Royal Wall Power Rack II. 500** | Article no: KB02RI-012 · **03 Royal Wall Power Rack II. 900** | Article no: KB02RI-012 · **04 Royal Air Rack I**
 | Article no: KB07RI-005 · **05 Royal TNT Fold Rack II. I** Folding system | Article no: KB02RI-010 · **06 Royal Wall Squat Station 300** | Article no: KB02RI-020-02 · **07 Royal Wall Squat Station 500** | Article no: KB02RI-021-02 · **08 Royal Swedish Espalier** | Article no: KB07RI-016



05



11

· **09 Royal Power Rack CX-30**
 | Article no: KB04RI-021-02 · **10 Royal Power Rack CX-30 Short**
 | Article no: KB04RI-022-02 · **11 Royal Power Rack CX-35** | Article no: KB04RI-006-04 · **12 Royal Power Rack CX-35 Short** | Article no: KB04RI-018-03 · **13 Royal Power Rack CX-37** | Article no: KB04RI-012-04 · **14 Royal Power Rack CX-37 Short** | Article no: KB04RI-019-02



12



06



07



08



13



14



MIGHTY RACKS

80 X 80 MM PROFILE

01 Mighty Squat Rack SX-10 | Article no: KB-04MI-006 · **02 Mighty Squat Rack SX-15** | Article no: KB04MI-003 · **03 Mighty Squat Rack SX-15 with modular gripers** | Article no: KB04MI-039 · **04 Mighty Squat Rack SX-20** | Article no: KB-04MI-004 · **05 Mighty Squat Rack SX-20 with Storage** | Article no: KB04MI-038 · **06 Mighty Squat Rack SX-25** | Article no: KB04MI-007



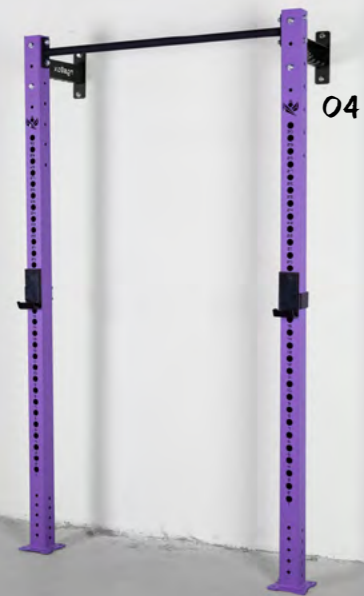
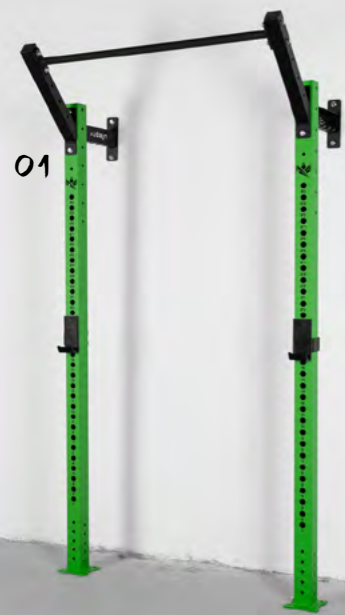

01 Mighty Power Wall Rack 300 I
Article no: KB02MI-006 · **02 Mighty Power Wall Rack 500 I** Article no: KB02MI-007 · **03 Mighty Power Wall Rack 500 I** Article no: KB02MI-013 · **04 Mighty Wall Squat Station 300 I** Article no: KB02MI-033 · **05 Mighty Wall Squat Station 500 I** Article no: KB02MI-034 · **06 Mighty Power Rack CX-30 Short I** Article no: KB04MI-037 · **07 Mighty Power Rack CX-30 I** Article no: KB04MI-036 · **08 Atlas Stone Rack I** Article no: KB06RI-032 · **09 Mighty Swedish Espalier I Steel PU Bar I** Article no: KB07MI-005 · **10 Mighty Swedish Espalier I Wooden PU Bar I** Article no: KB07MI-001 · **11 Mighty Power Rack CX-35 Short I** Article no: KB04MI-019 · **12 Mighty Power Rack CX-35 I** Article no: KB04MI-010 · **13 Mighty Power Rack CX-35 with Storage I** Article no: KB04MI-027 · **14 Mighty Power Rack CX-37 Short I** Article no: KB04MI-020 · **15 Mighty Power Rack CX-37 I** Article no: KB04MI-011



OUTDOOR

Warmer days are perfect for training outside, under the sun and in the fresh air, wouldn't you agree? Since we know how it feels to train inside a sweaty place, trying to catch some air between the reps, we decided to design this outdoor rig that will satisfy even the most demanding athletes and their needs.



01 Mighty Outdoor Fort I Article no: KB11MI-007 · 02 Mighty Outdoor Power Rack CX-35 I Article no: MA-010-0191

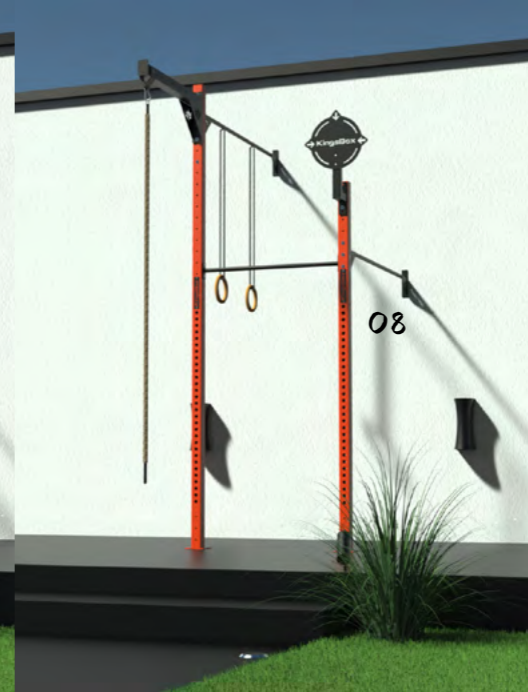

01 Mighty ZN Monkey Wall Rig I Article no: KB03MI-020 · **02 Mighty ZN Monkey Free-standing Rig I** Article no: KB03MI-031 · **03 Mighty Outdoor Wall Rig I** Article no: KB02MI-020 · **04 Mighty Outdoor Free-standing Rig I** Article no: KB01MI-009 · **05 Mighty Outdoor Squat Rack SX-10 I** Article no: KB04MI-032 · **06 Mighty Outdoor Squat SX-15 I** Article no: KB04MI-033 · **07 Mighty Backyard WR-2 I** Article no: KB04MI-033 · **08 Mighty Backyard WR-2 PU BAR I** Article no: KB02MI-010 · **09 Mighty Backyard FR-4 I** Article no: KB01MI-008 · **10 Mighty Backyard FR-4 PU BAR I** Article no: KB01MI-009 · **11 Mighty Outdoor Tower I** Article no: KB01MI-010 · **12 Mighty Outdoor Mountain I** Article no: KB01MI-012 · **13 Mighty Main Base Outdoor Rig I** Article no: KB01MI-011

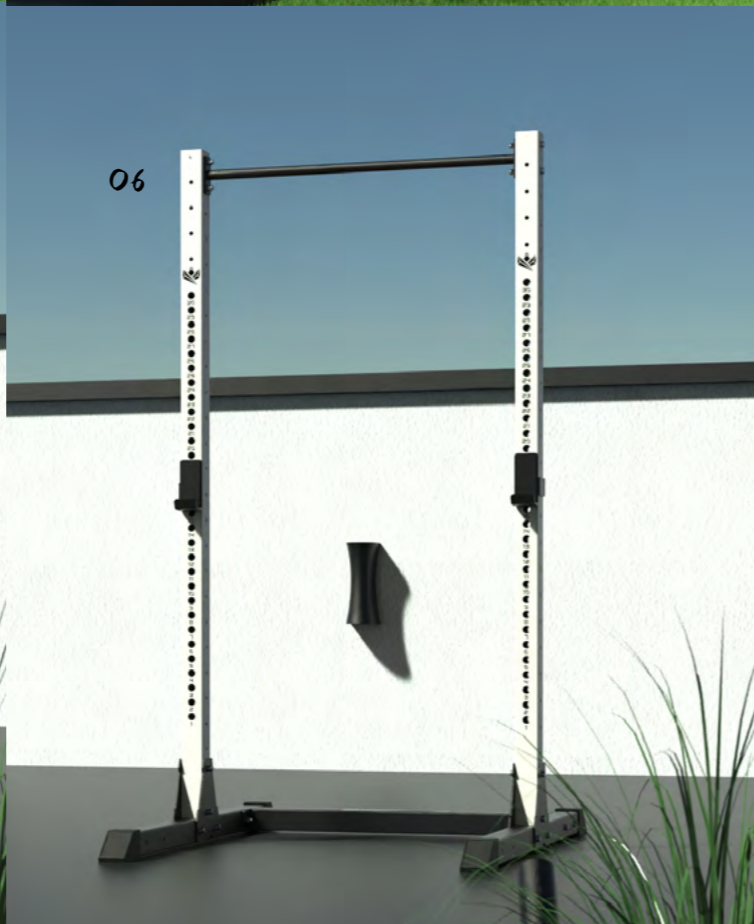
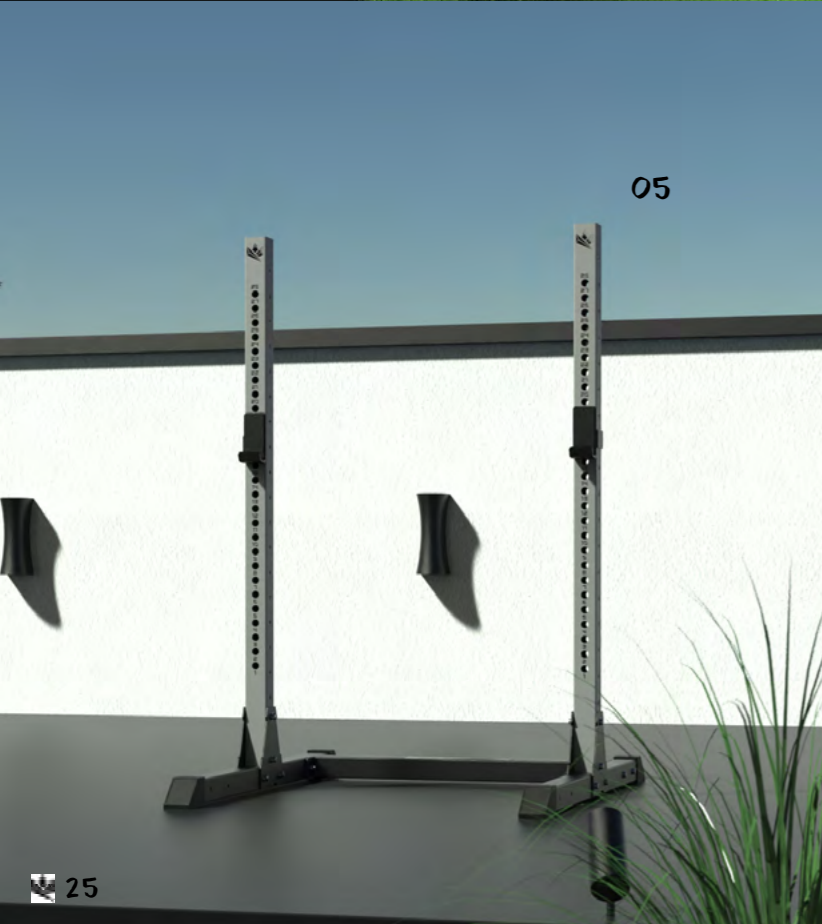

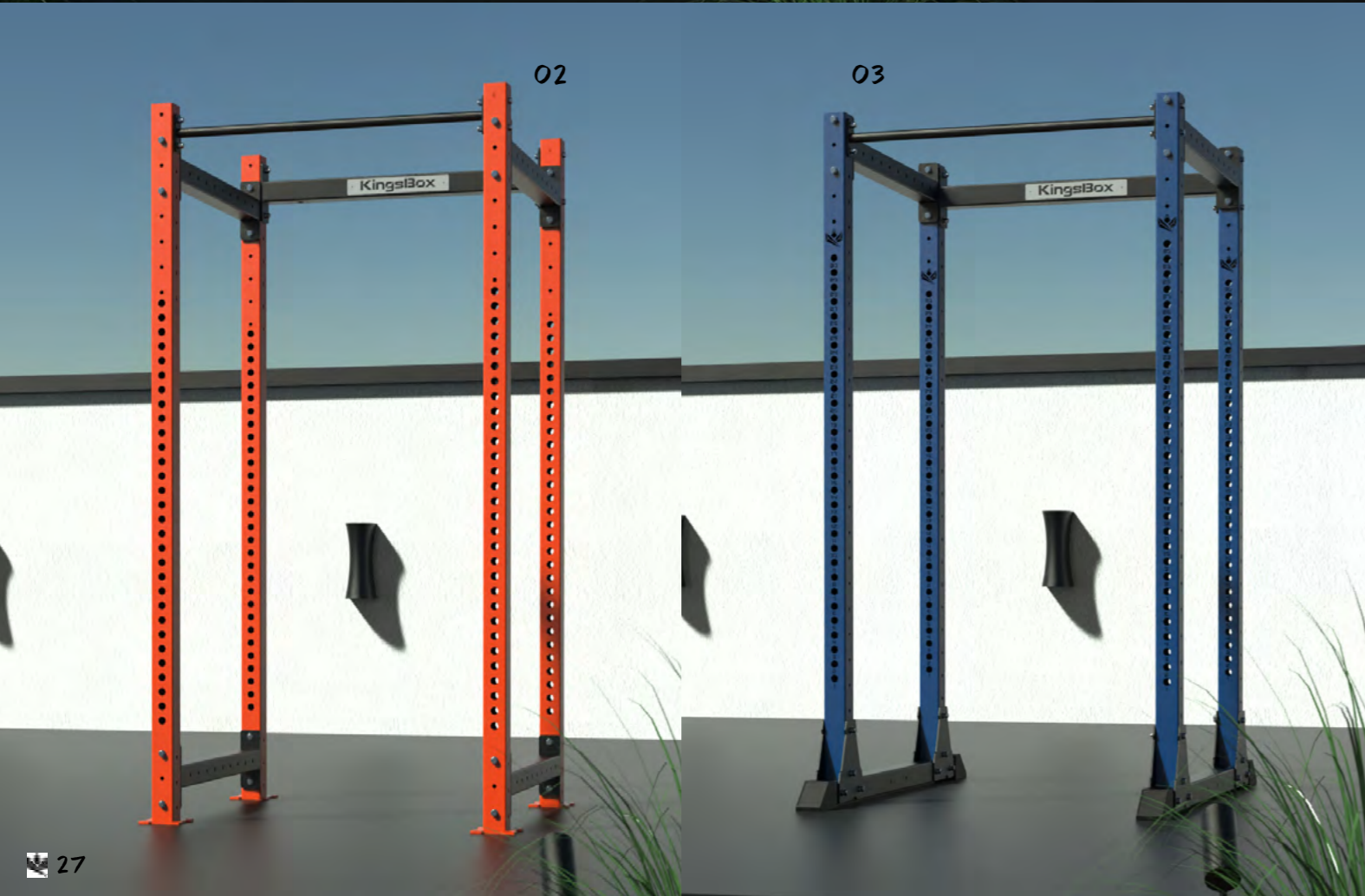

OUTDOOR ACCESSORIES

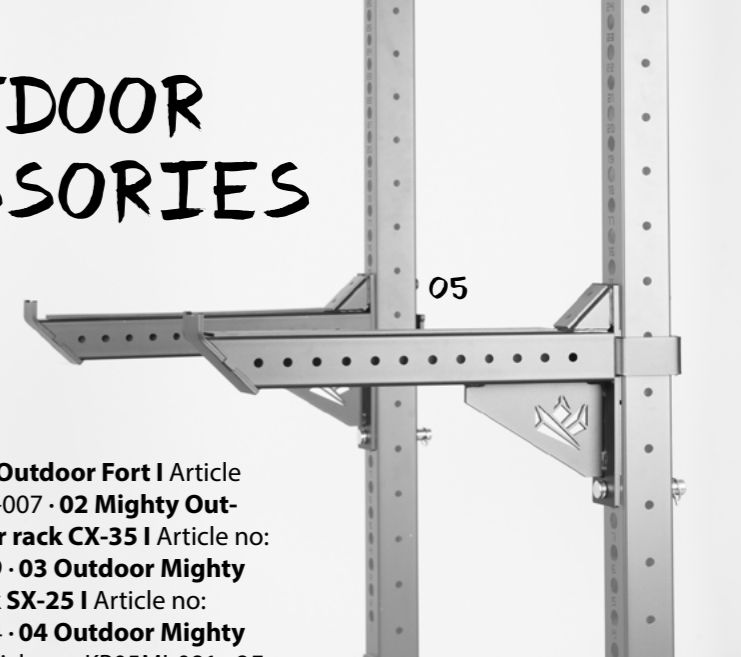
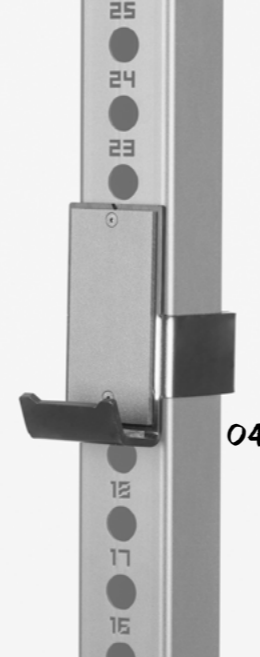

01 Mighty Outdoor Fort I Article no: KB11MI-007 · **02 Mighty Outdoor power rack CX-35 I** Article no: KB04MI-009 · **03 Outdoor Mighty Squat Rack SX-25 I** Article no: KB04MI-034 · **04 Outdoor Mighty J-Cups I** Article no: KB05MI-081 · **05 Outdoor Mighty Angel Arms I** Article no: KB05MI-082-KT · **06 Outdoor Mighty Dip Bar I Side fit I** Article no: KB05MI-083-KT · **07 Outdoor Mighty Dip Bar I Front fit I** Article no: KB05MI-084-KT · **08 Outdoor Hook Battle Rope I** Article no: KB05MI-086-KT · **09 Outdoor Mighty Mortar Bumper Rack I** Article no: KB05MI-085

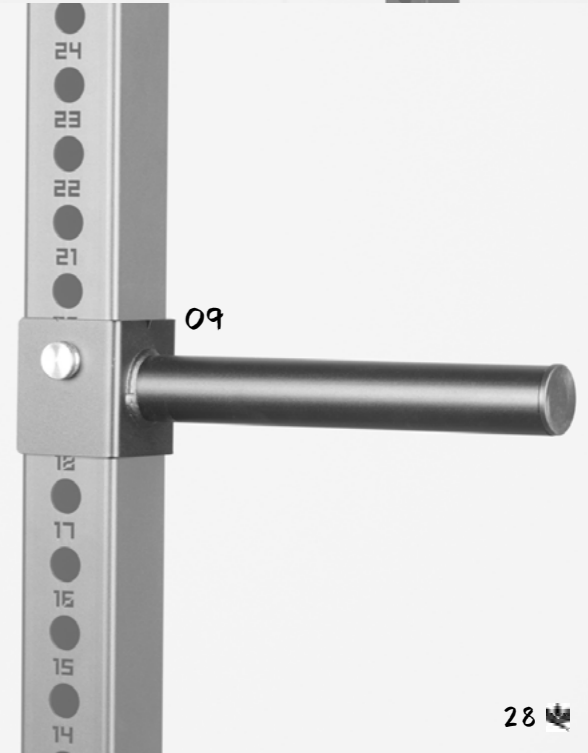
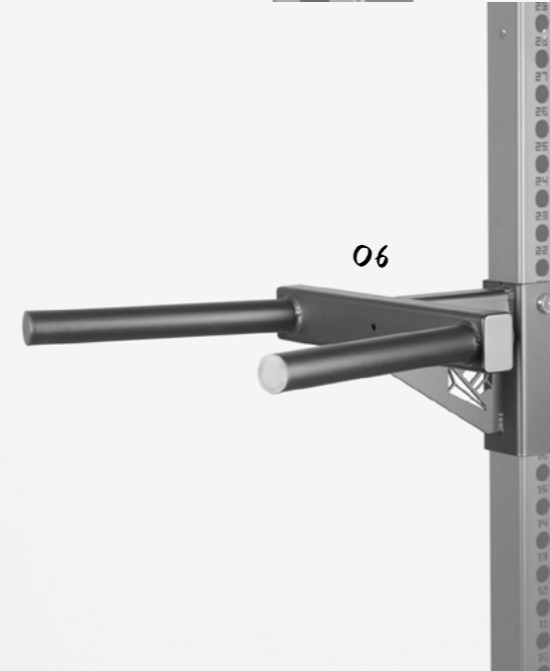

ONE PERSON GYM SET

02

We were looking for a practical and economical solution for small studios and home gyms. That is how we came up with the idea for Studio Upright.

A 250 cm high upright column, that is fixed to the floor with safety bolts. It is compatible with all accessories from our Mighty series. That way you can choose the combination that best fits your type of training.

You can start with Startup Bar & Plyo Platform, and then add more accessories with time. Our quick fit system means you can easily switch between different accessories. This way you can have a simple one-column structure that does not take up much room but at the same time offers endless training possibilities.

01 Studio Upright F 2500 I
Article no: 1326000 · **02 One Person Gym Set I** Article no:
HGS-010-1611

01



ACCESSORIES

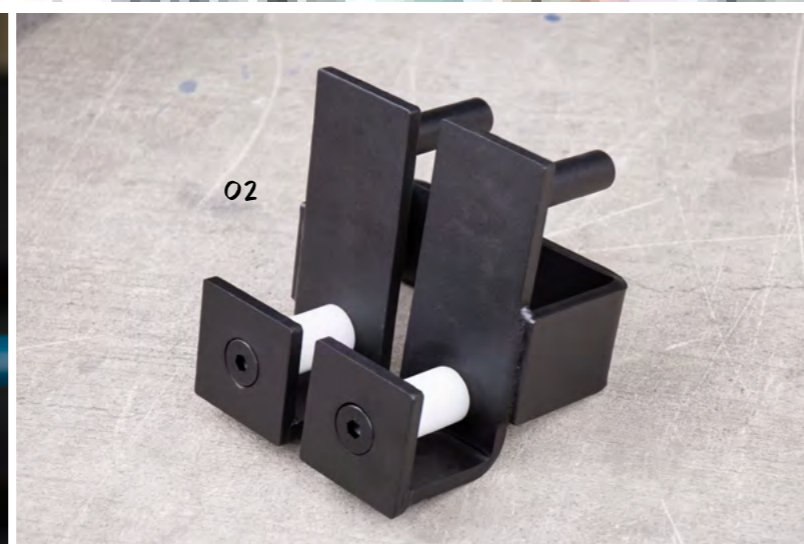
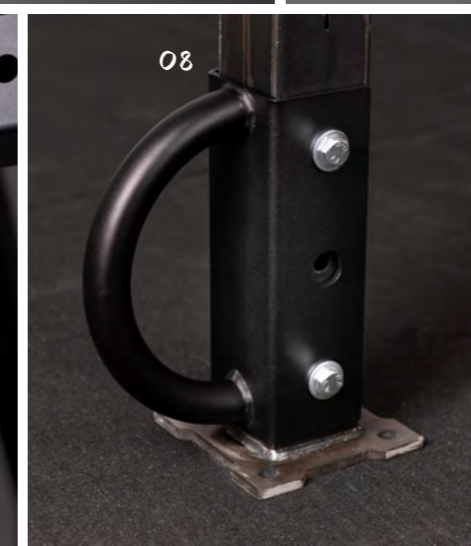
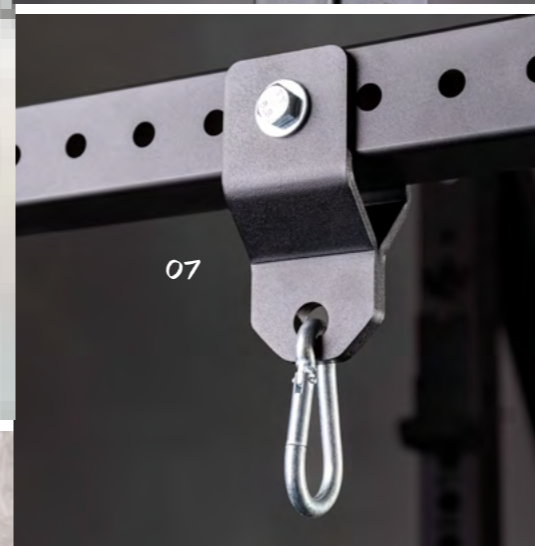

01 Mighty Super J-Cups | Article no: X-064-3000 • **02 Mighty Roller J-cups** | Article no: X-064-3010 • **03 Mighty J-Cups** | Article no: X-064-2000 • **04 Royal J-Cups** | Article no: X-064-1000 • **05 Mighty Super J-Cups with crown** | Article no: X-064-1000 • **06 Barbell Holder** | Article no: KB05RI-037 • **07 Iron Hand** | Royal or Mighty | Article no: 4118000, 4218000 • **08 Hook Battle Rope** | Royal or Mighty | Article no: KB05RI-035, KB05MI-026 • **09 Wall Ball Target** | Royal or Mighty | Article no: KB05RI-005, KB05MI-043 • **10 SX Wheels** | Royal or Mighty | Article no: KB05RI-056, KB05RI-053 • **11 Double Wall Ball Target** | Royal or Mighty | Article no: KB05RI-031, KB05MI-051

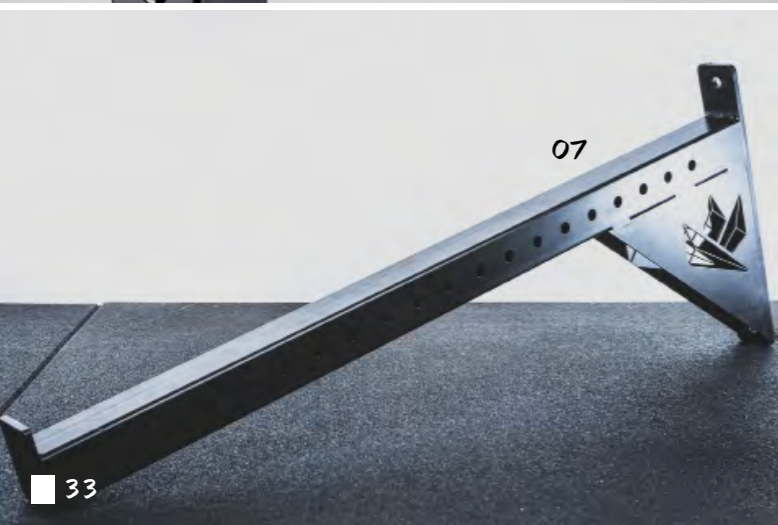
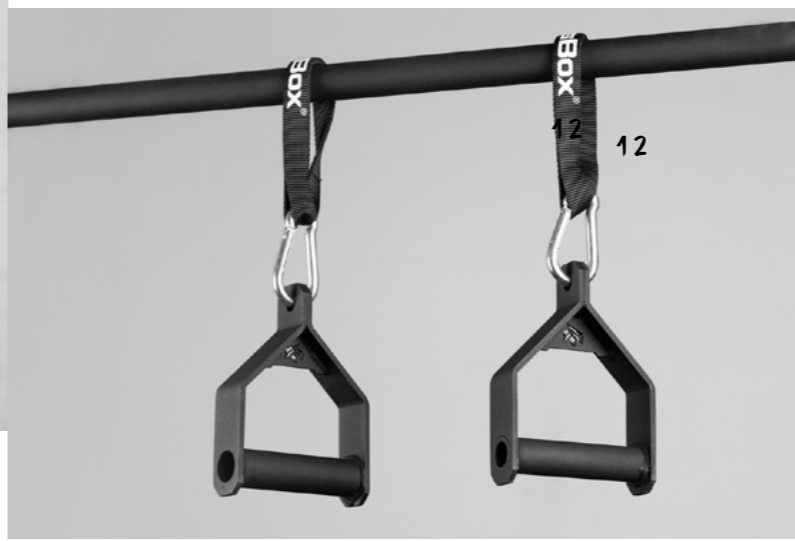
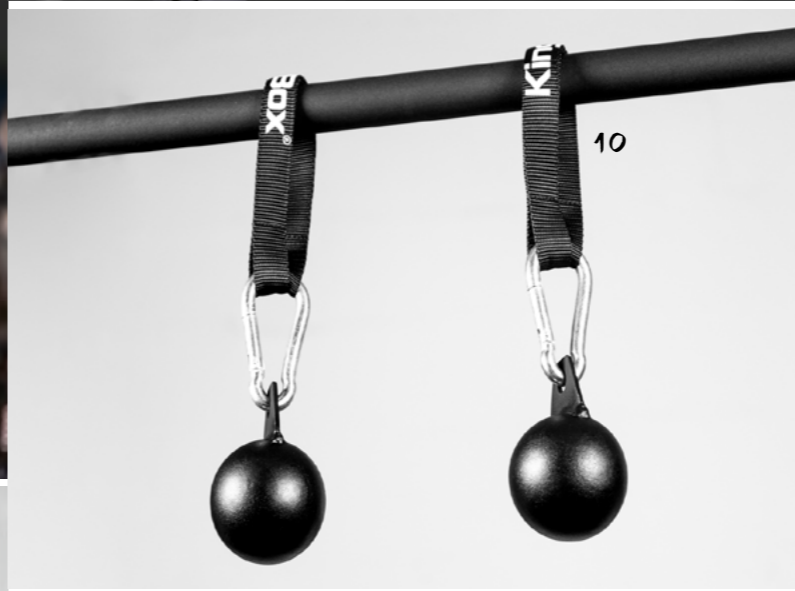
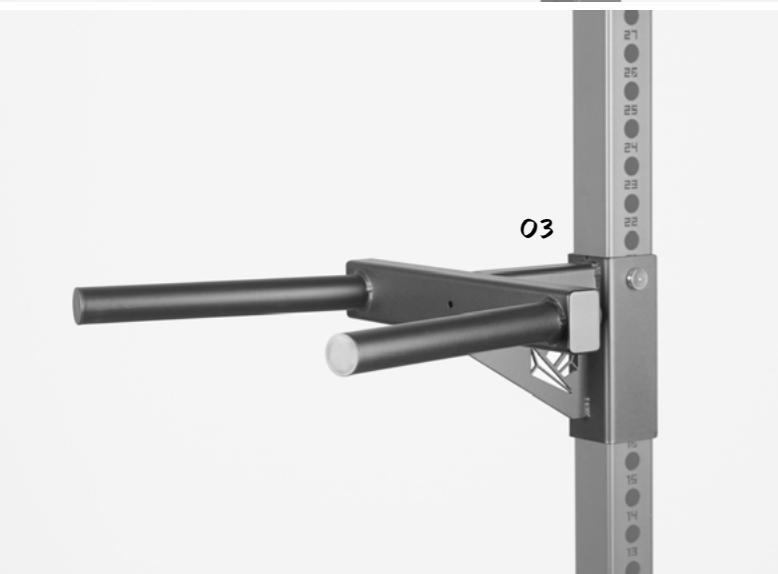
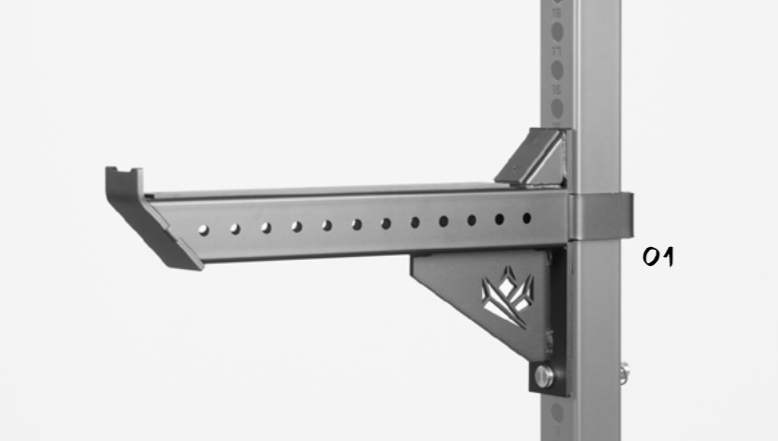

01 Mighty Angel Arms II. | Article no: KB05MI-015 • **02 Royal Angel Arms**
 | Article no: KB05RI-022 • **03 Dip Bar** | Royal or Mighty, Front or Side Fit | Article
 no: KB05RI-034, KB05RI-033, KB05MI-025, KB05MI-024 • **04 Ladder for**
Ring | Royal or Mighty | Article no: MA-010-0247, MA-010-0076 • **05 Mortar**
Bumper Rack | Royal or Mighty | Article no: KB05RI-021, KB05MI-009 • **06**
Start Up Bar | Royal or Mighty | Article no: 4124000, 4241000 • **07 Royal**
Branch | Royal or Mighty | Article no: 4115000, 4215000 • **08 Plyo Platform**
ma | Royal or Mighty | side fit | Article no: KB05MI-038 • **09 Plyo Platform**
I | Royal or Mighty | front fit | Article no: KB05MI-014 • **10 KingsBox**
Cannonball Grips | Article no: X-084-5200 • **11 KingsBox Cannonball Grips**
I | Article no: X-084-5200 • **12 Handle 360** | Article no: KB06RI-042 • **13**
KingsBox Cylinder Grips | Article no: X-084-5210 • **13 Wall Battle Rope**
Hook | Article no: X-064-7300 • **14 Mighty Mount Mobility Roller** | Ar-
 ticle no: X-084-7100 • **15 Royal Plyo Platforma** | Article no: KB05RI-026 •
16 Telephone Support | Royal or Mighty | Article no: MA-010-0105 • **16**
Space Saving Hook | Royal or Mighty | Article no: KB05RI-046, KB05MI-049

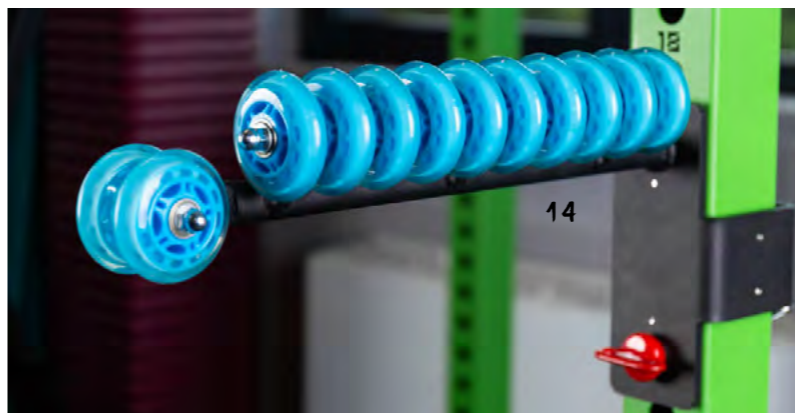

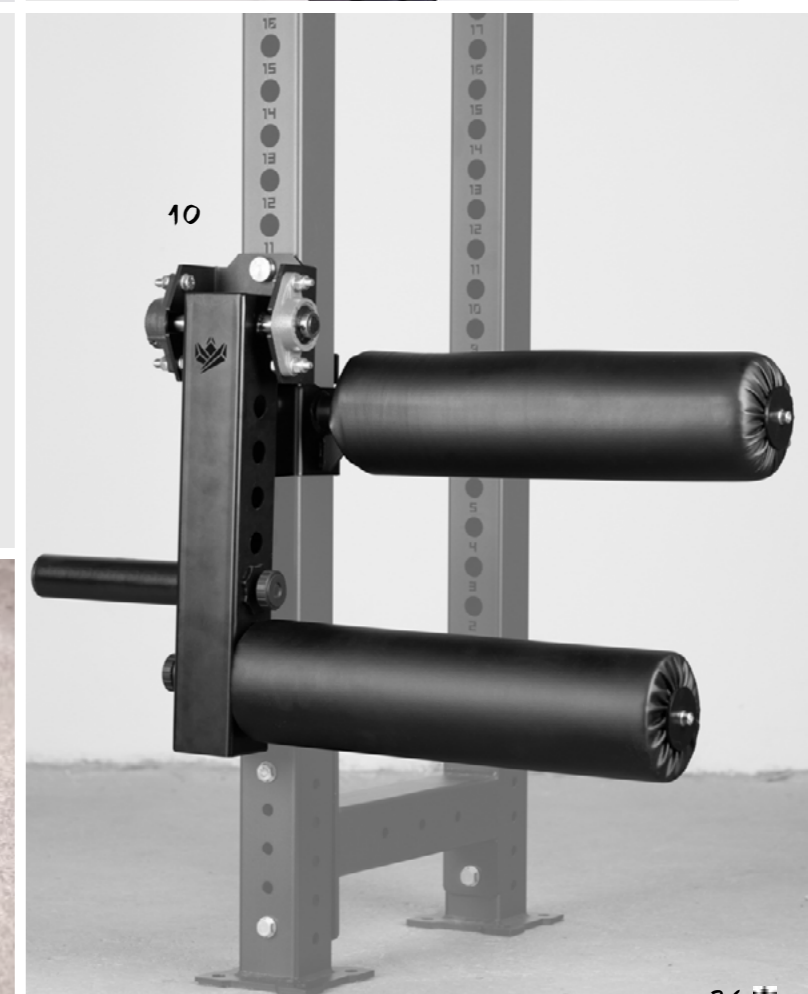
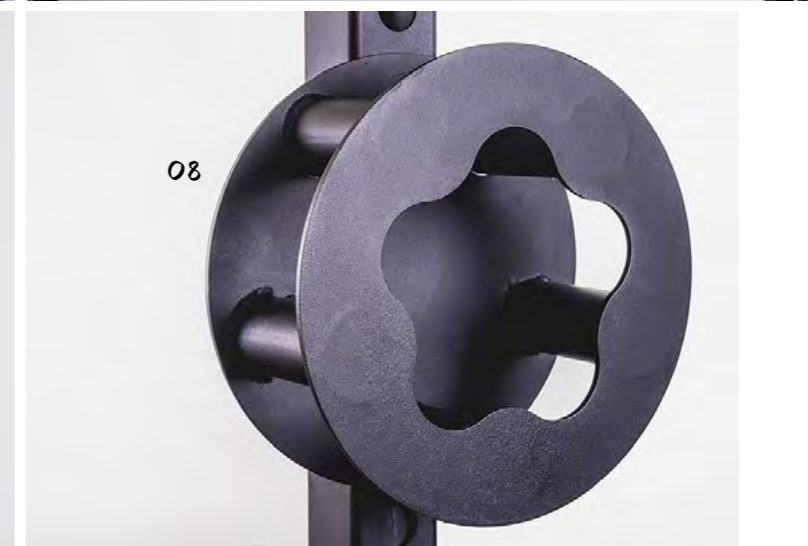

01 Wall Ball Target Sticker | Cracked-pink, Cracked-blue, Cracked-white, Black, White, Blue, Pink | Article no: X-097-6114 02 KingsBox Modular Grip | Royal or Mighty | Article no: KB05RI-017, KB05MI-050 • 03 KingsBox Pull Up Sphere 900 | Royal or Mighty | 70mm or 100mm | Article no: 4131000, 4132000 • 04 Safety Catchers 900 | Royal or Mighty | Article no: KB05RI-013, KB05MI-003 • 05 Natural PU Bar | Royal or Mighty | Article no: KB05RI-014, KB05MI-068 • 06 Fat Grip Bar | Royal or Mighty | Article no: KB05RI-081, KB05MI-091 • 07 Mighty Rope Hacker with Fasten | Article no: KB05MI-063 • 08 Rope Hacker | Article no: KB05RI-015 • 09 Spray in Standart Colors | Article no: KB09MI-046 • 10 Rack Leg Extension | Royal or Mighty | Article no: KB05RI-087, KB05MI-099 • 11 Bracket for Squat Stand SX | Royal or Mighty | Article no: KB05RI-064

JAMMER ARMS

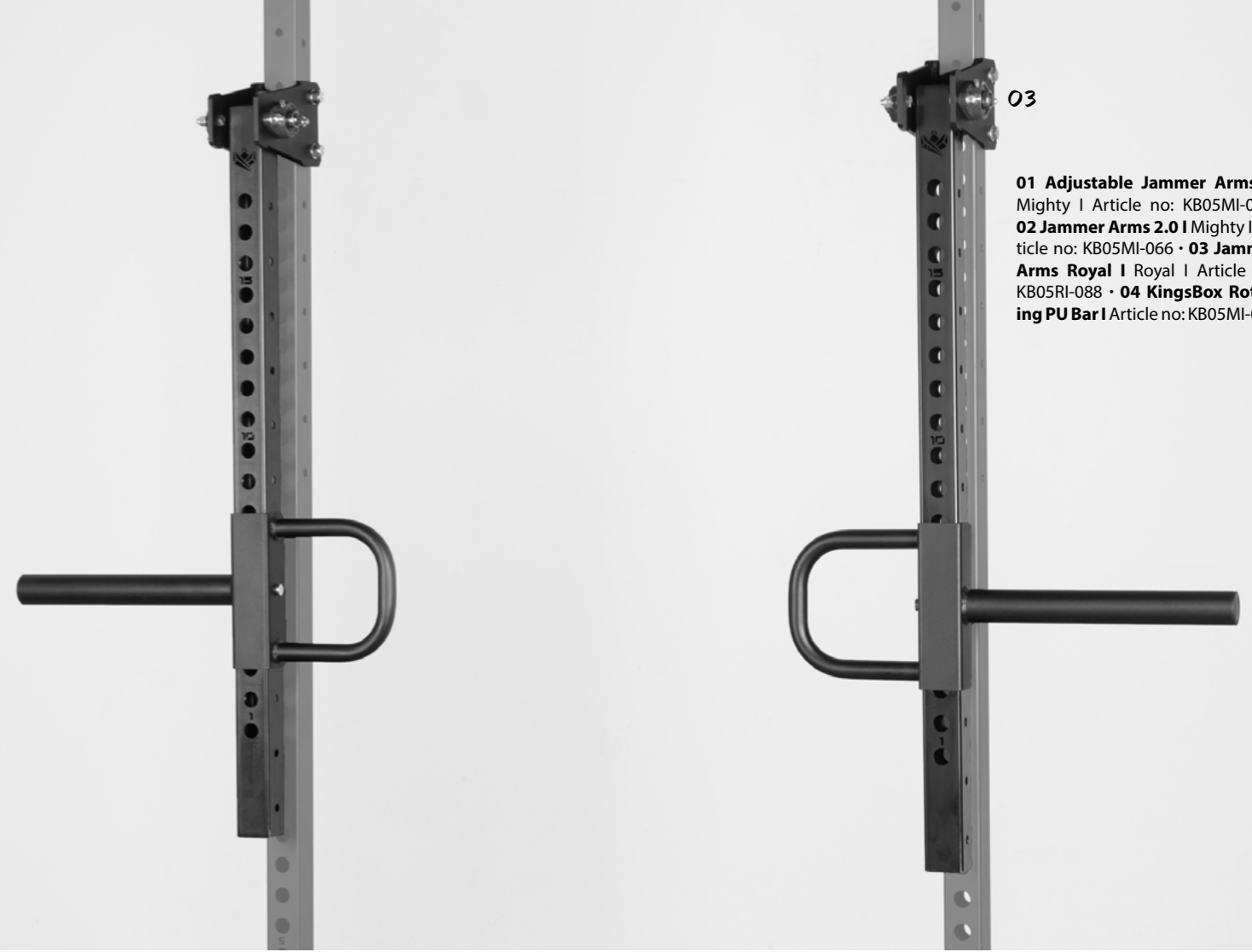
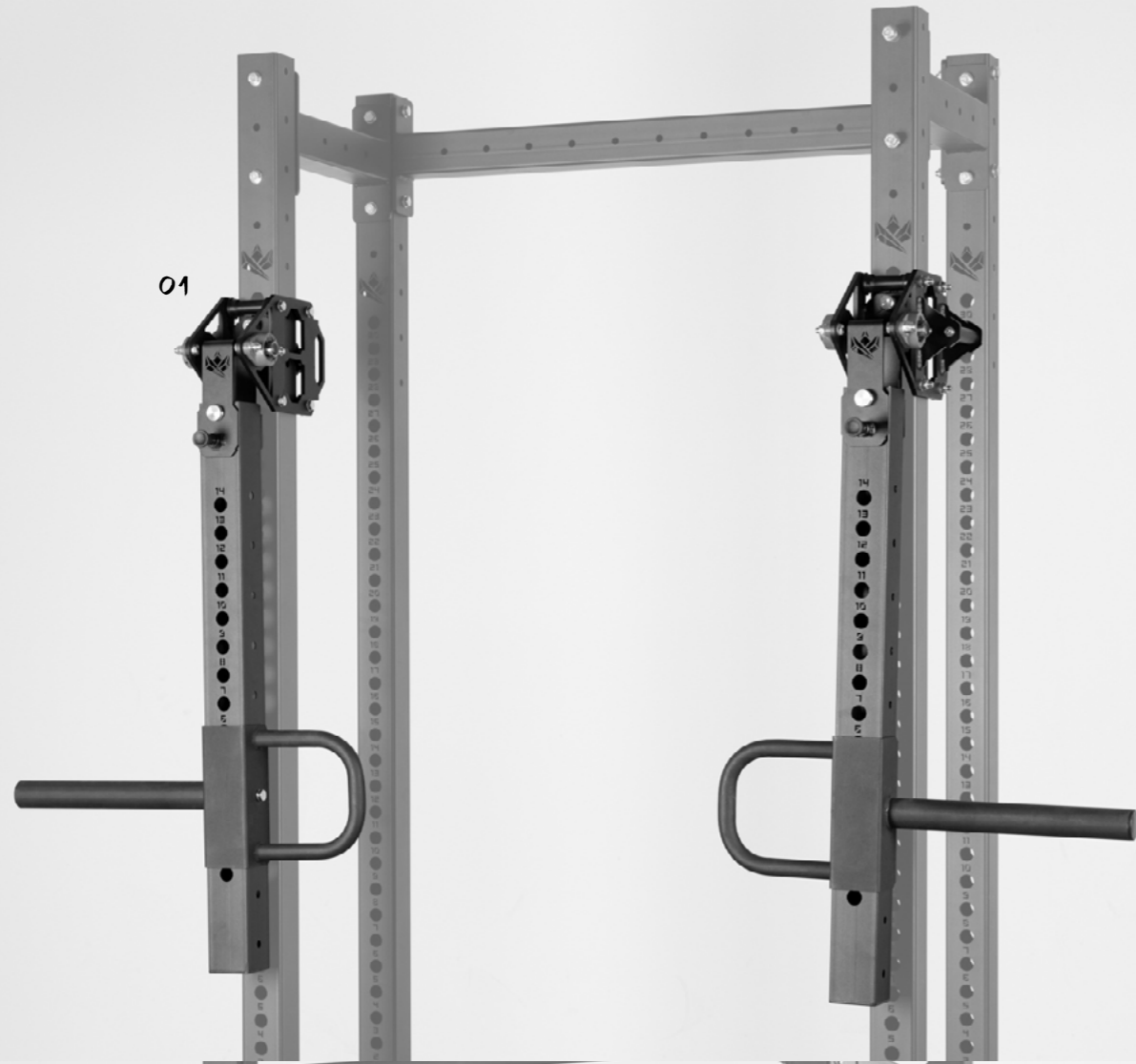

01 Adjustable Jammer Arms | Mighty | Article no: KB05MI-036
02 Jammer Arms 2.0 | Mighty | Article no: KB05MI-066 • 03 Jammer Arms Royal | Royal | Article no: KB05RI-088 • 04 KingsBox Rotating PU Bar | Article no: KB05MI-037



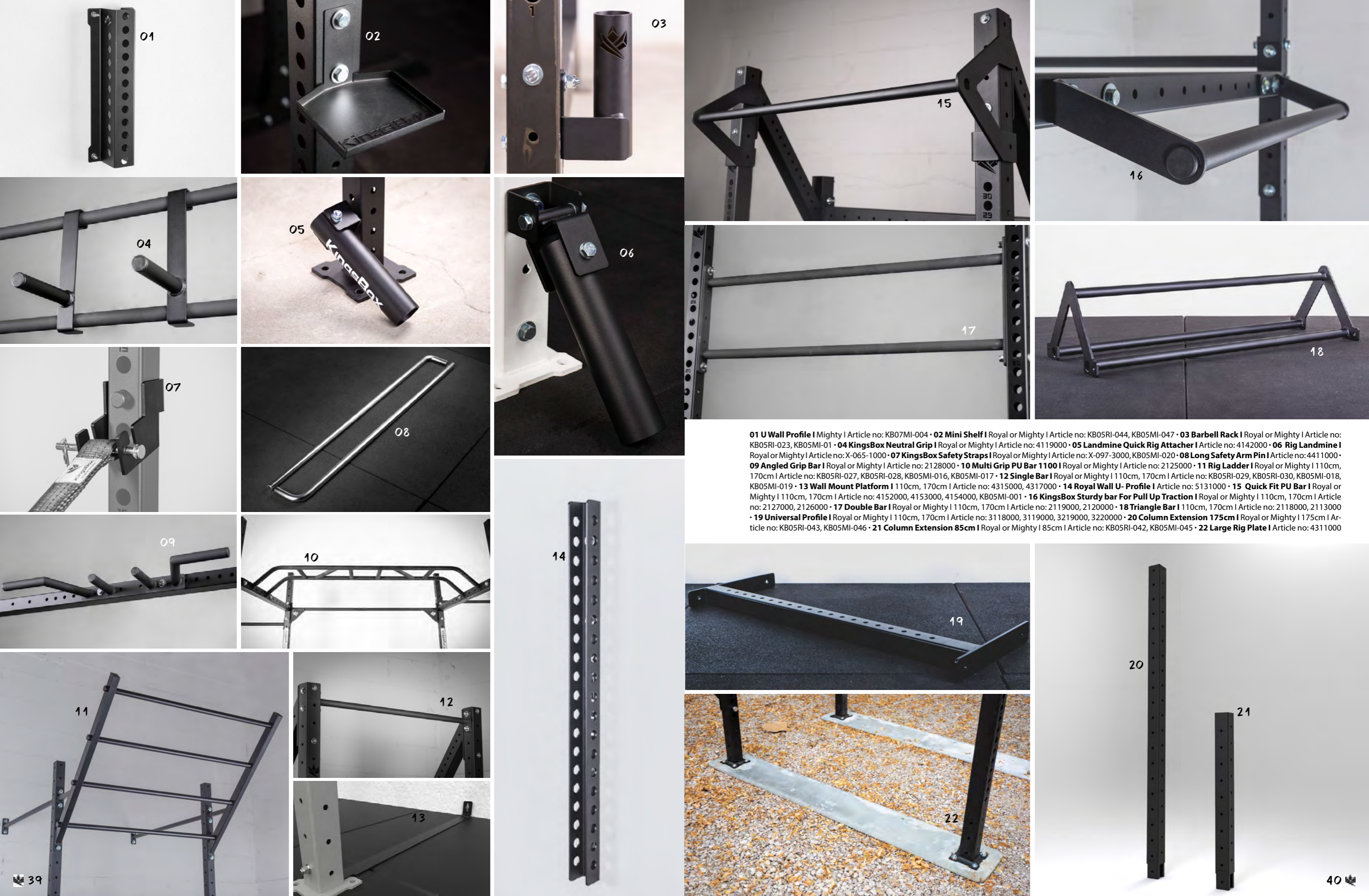

01 U Wall Profile | Mighty | Article no: KB07MI-004 • **02 Mini Shelf** | Royal or Mighty | Article no: KB05RI-044, KB05MI-047 • **03 Barbell Rack** | Royal or Mighty | Article no: KB05RI-023, KB05MI-01 • **04 KingsBox Neutral Grip** | Royal or Mighty | Article no: 4119000 • **05 Landmine Quick Rig Attacher** | Article no: 4142000 • **06 Rig Landmine** | Royal or Mighty | Article no: X-065-1000 • **07 KingsBox Safety Straps** | Royal or Mighty | Article no: X-097-3000, KB05MI-020 • **08 Long Safety Arm Pin** | Article no: 4411000 • **09 Angled Grip Bar** | Royal or Mighty | Article no: 2128000 • **10 Multi Grip PU Bar 1100** | Royal or Mighty | Article no: 2125000 • **11 Rig Ladder** | Royal or Mighty | 110cm, 170cm | Article no: KB05RI-027, KB05RI-028, KB05MI-016, KB05MI-017 • **12 Single Bar** | Royal or Mighty | 110cm, 170cm | Article no: KB05RI-029, KB05RI-030, KB05MI-018, KB05MI-019 • **13 Wall Mount Platform** | 110cm, 170cm | Article no: 4315000, 4317000 • **14 Royal Wall U- Profile** | Article no: 5131000 • **15 Quick Fit PU Bar** | Royal or Mighty | 110cm, 170cm | Article no: 4152000, 4153000, 4154000, KB05MI-001 • **16 KingsBox Sturdy bar For Pull Up Traction** | Royal or Mighty | 110cm, 170cm | Article no: 2127000, 2126000 • **17 Double Bar** | Royal or Mighty | 110cm, 170cm | Article no: 2119000, 2120000 • **18 Triangle Bar** | 110cm, 170cm | Article no: 2118000, 2113000 • **19 Universal Profile** | Royal or Mighty | 110cm, 170cm | Article no: 3118000, 3119000, 3219000, 3220000 • **20 Column Extension 175cm** | Royal or Mighty | 175cm | Article no: KB05RI-043, KB05MI-046 • **21 Column Extension 85cm** | Royal or Mighty | 85cm | Article no: KB05RI-042, KB05MI-045 • **22 Large Rig Plate** | Article no: 4311000

COLUMNS AND COLUMNS EXTENSIONS

ROYAL OR MIGHTY

01

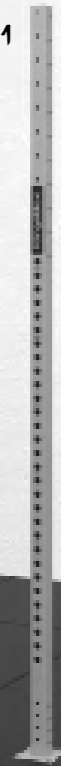

02



03



04



01 Column 2750 | Royal or Mighty | 275cm | Article no: KB05RI-020, KB05MI-007 · **02 Column 3600** | Royal or Mighty | 360cm | Article no: KB05RI-024, KB05MI-012 · **03 Column Extension 175cm** | Royal or Mighty | 175cm | Article no: KB05RI-043, KB05MI-046 · **04 Column Extension 85cm** | Royal or Mighty | 85cm | Article no: KB05RI-042, KB05MI-045



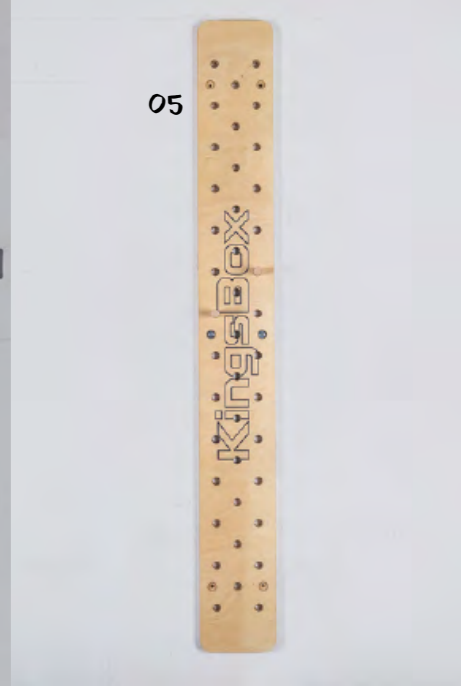

PULL UP BARS & PEGBOARD

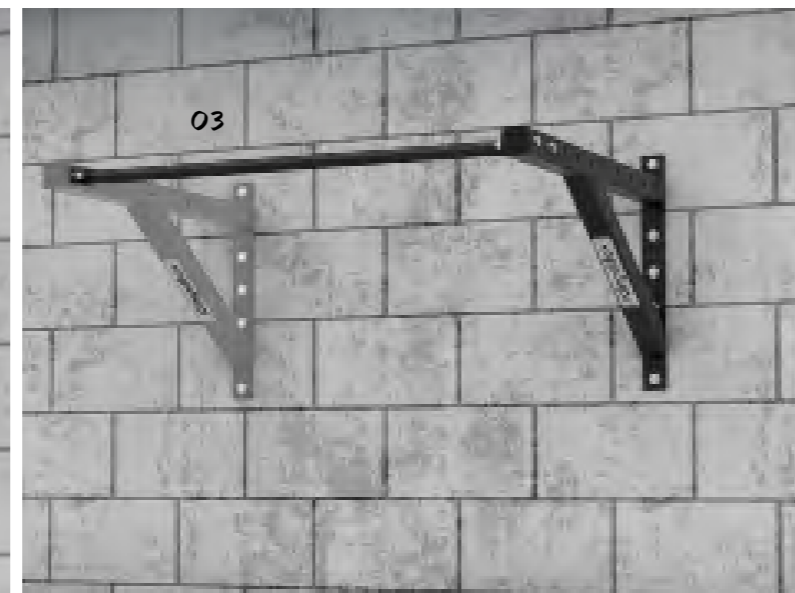
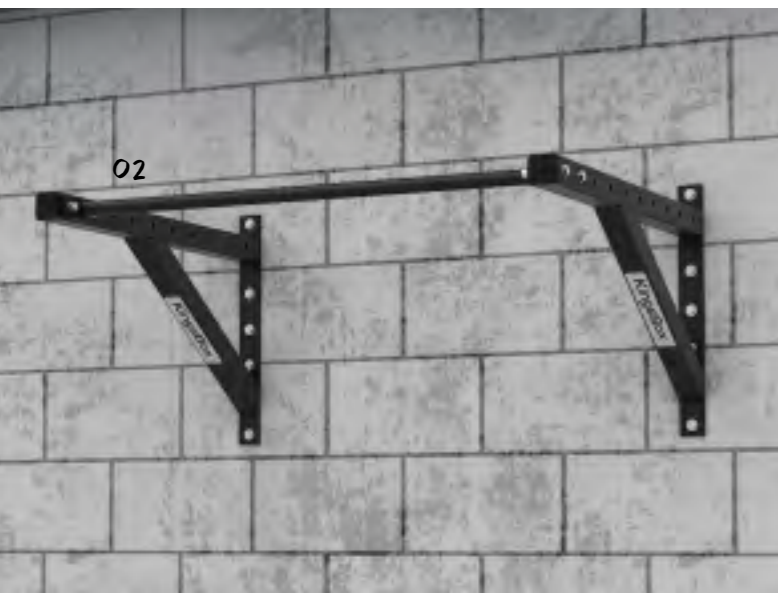

01 KingsBox 3 Seconds PU Bar | Article no: KB07RI-001 • 02 Modular PU Bar | Article no: X-075-2100 • 03 Modular PU Bar Extension | Article no: KB07RI-009 • 04 KingsBox Wall Pull Up Bar | Article no: X-075-2000 • 05 Kings Peg Board | Article no: KB07RI-007 • 06 Peg Board za Royal Rig | Article no: KB05RI-016 • 07 Steel Pegs Grip for Peg Board | Article no: X-075-4020

KINGSBOX CLOSET GYM

01

Inside the Closet

Stored in the closet you will find our famous Royal TNT rack with the adjustable Pull-Up Bar and a Folding Bench, Barbell hanger, and bumper storage. A perfect all-around training station on which you can train both pull-ups and do your barbell exercises.

Custom Exterior Design

The product is designed and made in Europe.

To make sure the Closet Gym will match the interior design of your apartment, you can choose between numerous color options from the catalog.

The feedback that we have got so far is amazing and we are happy to announce that the orders for our new Home Gym Closet are open !



A close-up photograph of a grey metal panel from a KingsBox MAD Series machine. The panel features a repeating pattern of small, stylized 'K' logos. A white brushstroke graphic is overlaid on the panel, containing the text 'KingsBox®' and 'MAD SERIES' in a bold, yellow font. The 'KingsBox' text is positioned above the 'MAD SERIES' text. The background shows the mechanical components of the machine, including a metal rod and a circular opening.

KingsBox®

MAD SERIES

KingsBox

THE MAD KING

A leg press machine designed for the real kings and queens

As the very name suggests, the leg press is a strength fitness device designed to perform the leg press exercise in a safe and controlled way.

Usually, each person has a dominant side of the body, for example, their right leg. When lifting, that dominant side takes up the larger share of the load. This means that the dominant side becomes even stronger and the difference between both legs becomes even greater. That is why we designed The Mad King - so that that plates can be pushed simultaneously with both legs or they can be separated and the trainee can train each leg individually.



Made in Europe

The device is made of profiles measuring 80 x 80, which have already been tested and are recognized as a KingsBox trademark. The profiles are connected by steel plates, which serve as an excellent connecting element and at the same time give the product the industrial and mighty look, which is a distinguishing feature in the KingsBox equipment.

Overcome the difference between both legs

The Mad King allows you to completely isolate your leg muscles and prevents the dominant leg from taking on the majority of the load. This is helpful for beginners that are not skilled enough to perform squats, for athletes recovering from injury, and also for those who want to completely isolate their leg muscles for optimal strengthening.

KB06MI-002-10

Scan & check



THE CRAZY QUEEN

We wanted to stay with our industrial style of design, so we used 80x80 profiles and cutout details that are typical for our equipment. The idea is that the design of the machine matches the rest of your gym.

Like with Mad King you can train each leg separately, preventing the dominant leg from taking the major part of the load. Thus you can work to minimize the difference between both legs. Crazy Queen is a plate-loaded machine. To add weight you use standard weight plates with a 50 mm hole diameter.



Crazy Queen will be most happy by the Mad Kings side. Both machines focus on building leg muscles. While the Mad Kings focuses on the leg press exercises, you can do two different exercises with the Crazy Queen.

One is seated leg extension with which you build your quadriceps muscles. But with a quick shift of the seating, you can also perform a lying leg curl. This exercise is focused on the posterior thigh muscle but it also helps train gluteus and hip flexors.

It comes in a grey-gold combination but if you would like it in a different color combination we can make it. Just write us at info@kingsbox.com.



KB06MI-024-10

Scan & check



YOUR GYM IN ONE MACHINE. MIGHTY SPS

SQUAT PULLY SYSTEM

It was a September afternoon. While we were sweating in our 'Office Gym' we came up with an ingenious idea: 'Why not design one training machine where you could complete your whole training routine?'. The idea was simple, but the realization – not so much! 9 months later, after prototyping and testing, we had our final product: The Mighty Squat Pulley System.

Mighty Squat pulley is a unique patented machine, on which you can perform belted squats, lat pulls, cable rows, and many other exercises for strength training. Now it's easier to understand its slogan: » Your gym in one machine.

The Mighty SPS is also available in shorter version called Mighty SPS – Base. It's perfect for Sport facilities or personal studios that are space limited.

The color of uprights is customizable. You can choose between Gold, Red, Blue, Green, Yellow, Orange, Grey, White or Black.

MIGHTY SPS

01

01 Mighty Squat Pulley System | Article no: KB04MI-008 •
02 Mighty SPS - BASE | Article no: MA-010-0184 • 03 Mighty SPS - ASD ON | Article no: MA-010-0185

02

MIGHTY SPS
BASE

03

STRENGTH MACHINES

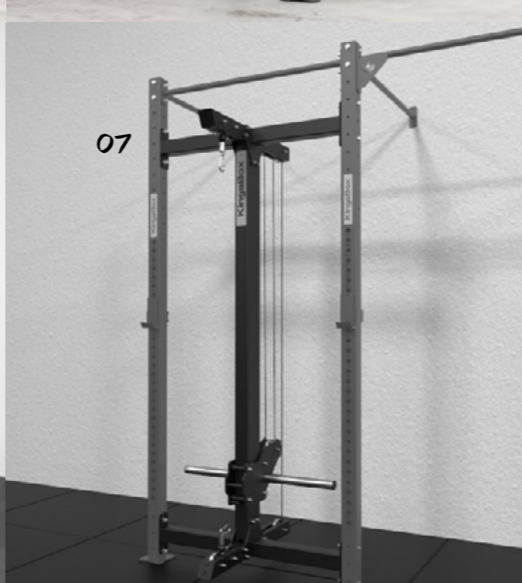
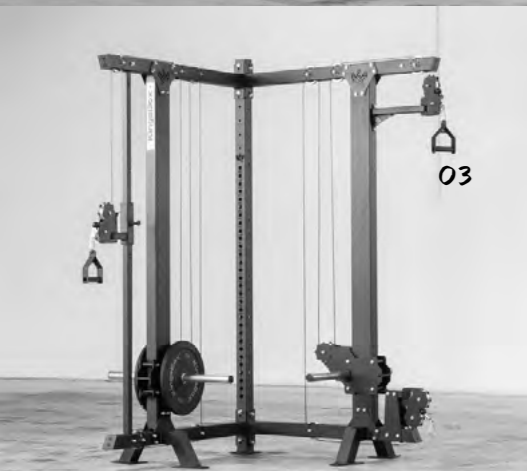
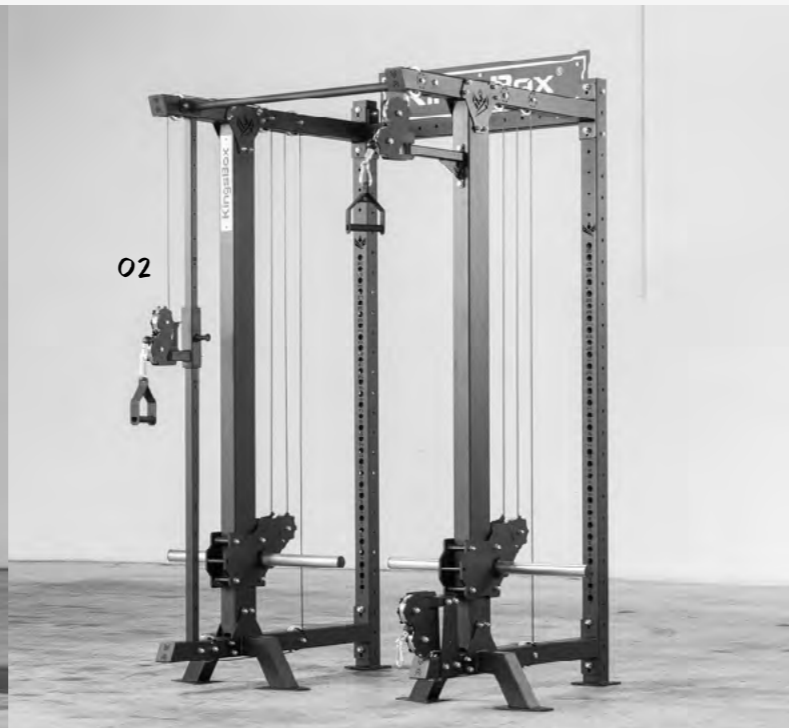

01 The Hydra I Article no: KB06MI-011 • **02 The Hydra Pulley Station I** Article no: KB06MI-023 • **03 KingsBox Cable Cross Over I** Article no: KB06MI-006 • **04 Cable Cross Over Kit I** Adjustable or Static I Article no: KB06MI-007, KB06MI-008 • **05 Mighty CX-35 CPS I** Article no: KB04MI-030 • **06 Mighty Lat Pull-down Crossover Machine I** Article no: X-096-7000 • **07 CPS Mighty I** Article no: KB05MI-067 • **08 Royal Home Pulley System I** Article no: KB05RI-062 • **09 Mighty Home Pulley System I** Article no: KB05MI-062 • **10 KingsBox Home Pulley System I** Migthy I Article no: X-097-8000 • **11 Fast Fit Pulley System I** Article no: KB05RI-055 • **12 Pulley Attachment I** Migthy I Article no: KB05MI-023 • **13 Kraken Pulley with attacher for Mighty rig I** Royal or Migthy Article no: KB05RI-103, KB05MI-120 • **14 KingsBox Kraken Pulley I** Article no: X-102-2000

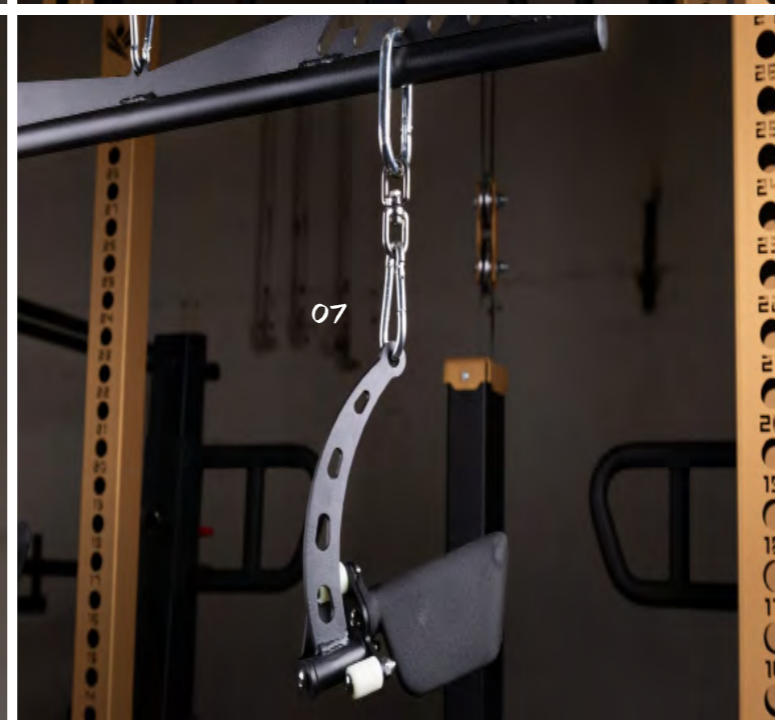
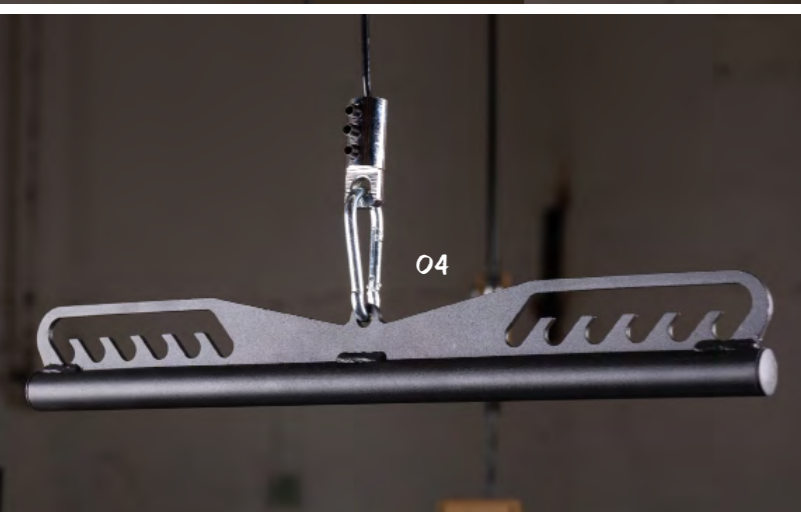

01 KingsBox Adjustable Handles I S | Article no: X-102-1010 • **02 KingsBox Adjustable Handles I M** | Article no: X-102-1020 • **03 KingsBox Adjustable Handles I L** | Article no: X-102-1030 • **04 KingsBox Adjustable Lat Destroyer I S** | Article no: X-102-1050 • **05 KingsBox Adjustable Lat Destroyer I L** | Article no: X-102-1060 • **06 KingsBox Adjustable Row Handle I** | Article no: X-102-1070 • **07 KingsBox Free Rotating Handles I** | Article no: X-102-1000 • **08 KingsBox Adjustable Bar Handles I** | Article no: X-102-1040 • **09 Lat Destroyer I** | Article no: KB06RI-059 • **10 KingsBox Barbell Row Handle I slim or fat** | Article no: KB06RI-028, KB06RI-027 • **11 Lat Pull Bar I** | Article no: KB05RI-092 • **12 Hercules Hold I** | Article no: KB06RI-040

BAR & PLATE

CUSTOMER SERVICE

MO - FRI 8:00 - 16:00

Telephone:
+386 30 351 866

E-mail:
info@kingsbox.it



Visit us on **facebook** at
facebook.com/kingsbox



Visit us on **instagram** at
[@kingsbox](https://instagram.com/kingsbox)



CERAKOTE

TRANSFORMING BARBELLS INTO ART

COLORS AVAILABLE



Since we are continuously setting new standards regarding quality and innovation of the Olympic barbells, it is time to present our Cerakote bars. This ceramic and polymer coating specifically enhances a number of physical performance properties including abrasion/wear resistance, corrosion resistance, chemical resistance, impact strength, and hardness. After a series of tests, the performance of Cerakote is seventy times better than chrome and even a hundred times better

than black zinc. Considering that this ceramic coating is used to coat military weapons, it is certainly good enough for our barbells. Olympic and powerlifting bars are inherently very robust, but with Cerakote coating, the durability is even more enhanced. You can choose between Black, Red, Blue, Pink, Yellow, Green, Grey or White, or the special colors White Sky, Blue Sky, or Pink Sky.



THE C-BAR CELIA GABBIANI



The C Bar Women's Olympic Barbell

- | Article no: KX-010-6010
- 15kg/ 25mm
- 195k PSI
- Dual knurl marks, No Center knurl
- Excellent knurling arrangement for functional workouts
- 4 needle roller Bearings
- Titanium Coating

The C Bar Men's Olympic Barbell

- | Article no: KX-010-6000
- 20kg/ 28mm
- 205k PSI
- Dual knurl marks, No Center knurl
- Excellent knurling arrangement for functional workouts
- 4 needle roller Bearings
- Titanium Coating



Kings Bar II. Olympic Barbell

- Article no: X-010-1000
- 20kg/ 28mm
- 190k PSI
- Dual knurl marks, No Center knurl
- Excellent knurling arrangement for functional workouts
- 4 needle roller Bearings
- Hard Chrome Coating



Dark Knight Bar

- Article no: X-010-1400
- 20kg/ 28mm
- 205k PSI
- Dual knurl marks, No Center knurl
- Suitable for Powerlifting and Olympic weightlifting
- 4 needle roller Bearings



Royal Bar Olympic Barbell

- Article no: X-010-1100
- 20kg/ 28mm
- 215k PSI
- Dual knurl marks, No Center knurl
- Excellent knurling arrangement for functional workouts
- 8 needle roller Bearings



White Knight Bar

- Article no: X-010-1300
- 20kg/ 28mm
- 205k PSI
- Dual knurl marks, No Center knurl
- Suitable for Powerlifting and Olympic weightlifting
- 4 needle roller Bearings



The Great WL Bar Olympic Barbell

- Article no: X-010-1500
- 20kg/ 28mm
- 215k PSI
- Olympic Weightlifting knurl marks, Center knurl
- Suitable for Olympic weightlifting
- 8 needle roller Bearings
- Hard Chrome Coating



The Great Bar

- Article no: X-010-1200
- 20kg/ 28mm
- 205k PSI
- Dual knurl marks, No Center knurl
- Suitable for Powerlifting and Olympic weightlifting
- 4 needle roller Bearings

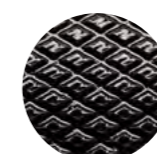

Royal WL Bar Olympic Barbell

- Article no: X-010-1510
- 20kg/ 28mm
- 215k PSI
- Olympic Weightlifting knurl marks, Center knurl
- Suitable for Olympic weightlifting
- 8 needle roller Bearings
- Hard Chrome Coating
- Fine rough knurling
- Handmade knurling

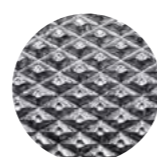

Power Warrior Bar

- Article no: X-010-1200
- 20kg/ 29mm
- 205k PSI
- Powerlifting knurl marks, Center knurl
- Suitable for Powerlifting
- Bushings
- Hard Chrome Coating





Royal Deadlift Power Bar

- Article no: X-010-1800
- 20kg/ 28,5mm
- 190k PSI
- Powerlifting knurl marks, No Center knurl
- Suitable for Powerlifting
- Bushings
- Black Zinc Coating
- Aggressive knurling



Gold Bar

- Article no: X-010-6100
- 20kg/ 28mm
- 205k PSI
- Dual knurl marks, No Center knurl
- Suitable for Powerlifting and Olympic weightlifting
- 8 needle roller Bearings
- Titanium Coating
- Medium rough knurling



Underground Power Bar

- Article no: X-010-1700
- 20kg/ 29mm
- 230k PSI
- Powerlifting knurl marks, Center knurl
- Suitable for Powerlifting
- Bushings
- Hard Chrome Coating
- Aggressive knurling



Longbow Bar

- Article no: X-011-7000
- 20kg/ 28mm
- 205k PSI
- Powerlifting knurl marks, Center knurl
- Suitable for Powerlifting
- 4 needle roller Bearings
- Hard Chrome Coating
- Medium rough knurling

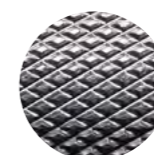

KingsBox Russian Bar

- Article no: X-010-5000
- 20kg/ 28mm
- 190k PSI
- Dual knurl marks, No Center knurl
- Suitable for Powerlifting and Olympic weightlifting
- 8 needle roller Bearings
- Hard Chrome Coating
- Medium rough knurling

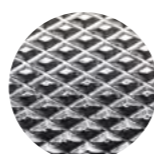

The Mad Bar

- Article no: KB14MB-003
- 20kg/ 28mm
- 180k PSI
- Dual knurl marks, No Center knurl
- Bushings
- Cerakote Coating
- Medium rough knurling

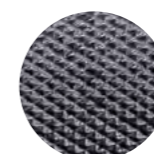

Wicked Bar

- Article no: X-011-8000
- 20kg/ 28mm
- 190k PSI
- Dual knurl marks, No Center knurl
- Suitable for Powerlifting and Olympic weightlifting
- 8 needle roller Bearings
- Hard Chrome Coating
- Medium rough knurling



The Mad Bar

- Article no: KB14MB-004
- 15kg/ 25mm
- 180k PSI
- Dual knurl marks, No Center knurl
- Bushings
- Cerakote Coating
- Medium rough knurling

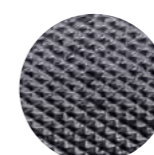



Queen Bar Olympic Barbell

Article no: X-010-2000

- 15kg/ 25mm
- 180k PSI
- Dual knurl marks, No Center knurl
- Excellent knurling arrangement for functional workouts
- Suitable for Powerlifting and Olympic weightlifting
- 4 needle roller Bearings
- Hard Chrome Coating
- Fine rough knurling

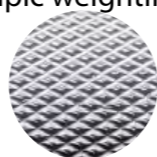

Prince Bar Olympic Barbell

Article no:

- 11kg/ 28mm
- 180k PSI
- Dual knurl marks, No Center knurl
- Technical training bar
- 4 needle roller Bearings
- Black Zinc Coating
- Fine rough knurling



Victoria Bar Olympic Barbell

Article no: X-010-2000

- 15kg/ 25mm
- 195k PSI
- Dual knurl marks, No Center knurl
- Excellent knurling arrangement for functional workouts
- Suitable for Powerlifting and Olympic weightlifting
- 4 needle roller Bearings
- Hard Chrome Coating
- Fine rough knurling



Junior Bar Olympic Barbell

Article no: X-010-3000

- 10kg/ 25mm
- 180k PSI
- Dual knurl marks, No Center knurl
- Technical training/ learning bar
- Suitable for beginners or children
- 4 needle roller Bearings
- Black Zinc Coating
- Fine rough knurling



Women's Royal WL Bar

Article no: X-010-2200

- 15kg/ 25mm
- 215k PSI
- Olympic Weightlifting, No Center knurl
- Suitable for Olympic weightlifting
- 8 needle roller Bearings
- Hard Chrome Coating
- Medium rough knurling

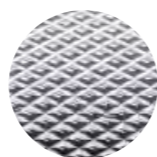

Mini Kid Bar

Article no: MA-010-0132

- 2.5kg/ 22mm
- No knurl marks
- Technical training/ learning bar
- Suitable for beginners or children
- 4 needle roller Bearings
- Anodised Aluminum Coating
- Fine rough knurling



Women's Royal WL Bar II.

Article no: X-010-2210

- 15kg/ 25mm
- 215k PSI
- Olympic Weightlifting, No Center knurl
- Suitable for Olympic weightlifting
- 8 needle roller Bearings
- Hard Chrome Coating
- Fine rough knurling

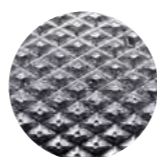

Junior Axle Bar

Article no: KB06RI-029

- 5kg/ 27mm
- No knurl marks
- Technical training/ learning bar
- Suitable for beginners or children
- Black powder Coating
- 40kg weight limit





EZ Curl Angled Barbell

- | Article no: X-011-5000
- 8.5kg/ 28mm
- Dual knurl marks, No Center knurl
- Bushings
- Hard Chrome Coating
- Fine rough knurling
- 125kg weight limit

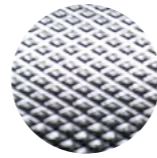

KingsBox Multi Grip Bar

- | Article no: X-011-3000
- 28kg/ 28mm
- Different Grip Angle
- Black powder Coating
- Fine rough knurling



KingsBox Olympic Dumbbell

- | Article no: X-046-1000
- 5.5kg/ 28mm
- Bushings
- Hard Chrome Coating
- Fine rough knurling
- 125kg weight limit

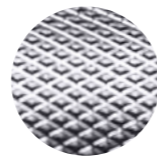

KingsBox Royal Hex Bar

- | Article no: X-011-4000
- 30kg/ 33mm
- Different Grip Angle
- Black powder Coating
- Medium rough knurling

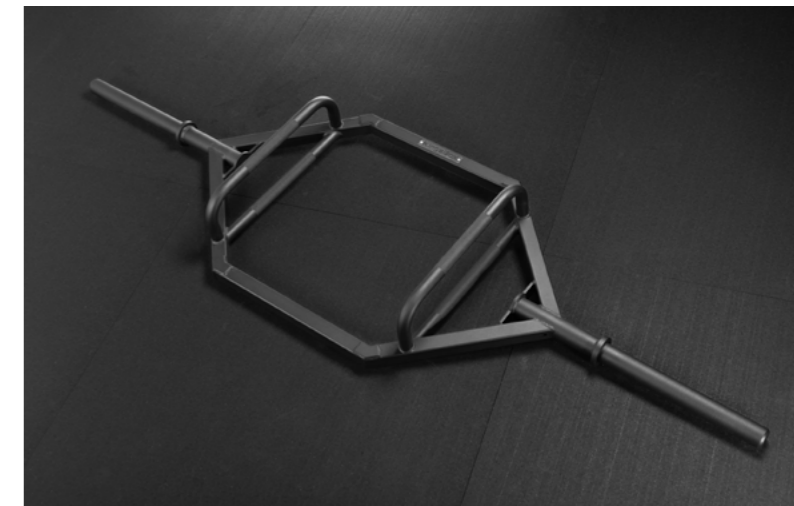

Goblet Safety Bar

- | Article no: X-011-2010
- 24kg/ 28mm
- Bushings
- Black Zinc Coating
- Memory Foam covered
- Fine rough knurling



Log Strongman ML-2

- | Article no: X-011-1000
- 30kg
- Neutral grip
- Black powder Coating
- Medium rough knurling



Power Squat Bar

- | Article no: 7114000
- 35kg/ 38mm
- Black powder Coating

Hex Bar Long Sleeve

- | Article no: KB06RI-043
- 30kg
- Neutral grip
- Black powder Coating
- Medium rough knurling





KingsBox Axle Bar
| Article no: KB06RI-030
- 8kg/ 48mm
- Black powder Coating



Duke Axle Bar
| Article no: KB06RI-031
- 11kg/ 48mm
- Black powder Coating



Axle Olympic Dumbbell Slim
| Article no: KB06RI-061
- 2,6 kg/ 28 mm
- Cataforesis



Axle Olympic Dumbbell Fat
| Article no: KB06RI-062
- 2,6 kg/ 50 mm
- Cataforesis

Hybrid Bar
| Article no: KB06RI-044
- 24kg
- Black powder Coating



Duchess Squat Bar
| Article no: KB06RI-063
- 25 kg/ 50 mm



Mighty Swiss Bar
| Article no: KB06MI-009
- 14 kg



PLATES



01

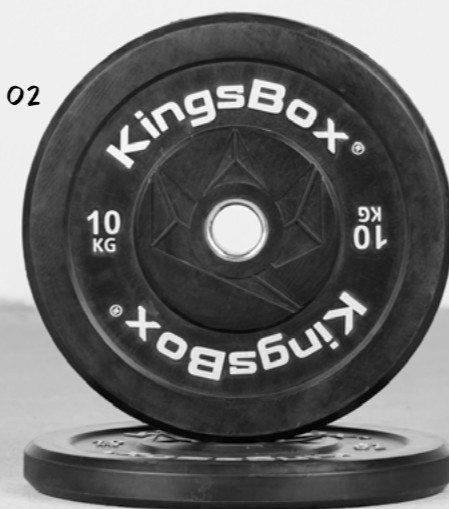

02



03



04



05



06



07



08



01 KingsBox Competition plates | 5kg, 10kg, 15kg, 20kg, 25kg | Article no: MA-010-0121 · 02 KingsBox Royal Black bumper plates | 5kg, 10kg, 15kg, 20kg, 25kg | Article no: MA-010-0067 · 03 KingsBox Hi-Temp bumper plates | 5kg, 10kg, 15kg, 20kg, 25kg | Article no: MA-010-0069 · 04 KingsBox Royal Color bumper plates | 5kg, 10kg, 15kg, 20kg, 25kg | Article no: X-013-1000, X-013-1100, X-013-1200, X-013-1300, X-013-1400 · 05 KingsBox Home bumper plates | 5kg, 10kg, 15kg, 20kg, 25kg | Article no: MA-010-0057 · 06 KingsBox Royal Sky Bumper Plates | 5kg, 10kg, 15kg, 20kg, 25kg | Article no: MA-010-0367 · 07 KingsBox Steel plates | 5kg, 10kg, 15kg, 20kg, 25kg | Article no: MA-010-0201 · 08 KingsBox Change Plates | 0.5kg, 1kg, 1.5kg, 2kg, 2.5kg | Article no: MA-010-0072



01 KingsBox Royal Rubber Micro Loads | 0.5kg, 1kg, 1.5kg, 2kg, 2.5kg | Article no: MA-010-0192 · **02 KingsBox Wagon Wheel** | 20kg | Article no: X-018-3000 · **03 KingsBox Hard Core Bumpers** | 5kg | Article no: X-019-1000 · **04 KingsBox Technical discs** | 2.5kg | Article no: X-012-1200 · **05 KingsBox Steel micro loads** | 0.5kg, 1kg, 1.5kg, 2kg, 2.5kg | Article no: MA-010-0200 · **06 KingsBox Oversize Technical plates** | 2.5kg | Article no: X-012-1800 · **07 KingsBox Magnetic Micro Weights** | 0.5kg | Article no: X-017-3010 · **08 KingsBox Magnetic Micro Weights** | 1kg | Article no: X-017-3110

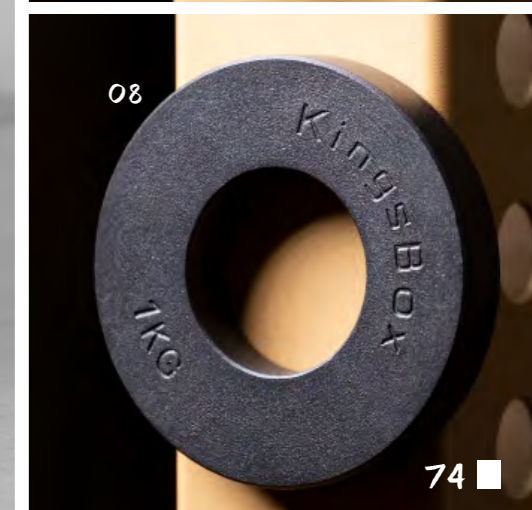
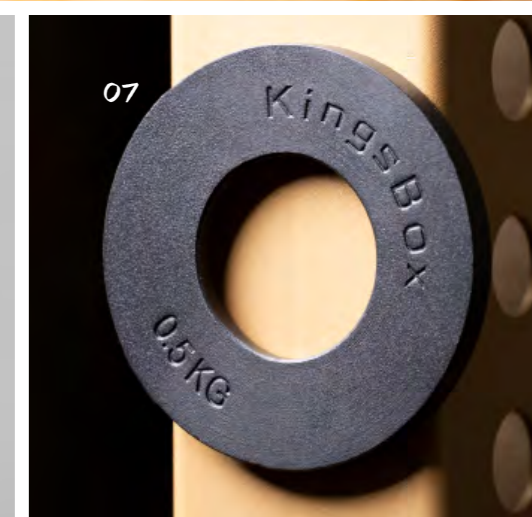

PROPS & ACCESSORIES



01 Kingsbox Round Jaw Collars | Article no: X-080-3100 · 02 KingsBox Lock Jaw Collar | Article no: X-080-2000 · 03 KingsBox Lock Aluminium Jaw | Article no: X-080-3000 · 04 KingsBox Competition Collars | Article no: X-080-4100 · 05 KingsBox Steel Lock Jaw | Article no: X-080-4000 · 06 KingsBox Spring Collars | Article no: X-080-1000 · 07 KingsBox Tick Lock Jaw | Blue, Black | Article no: X-080-2100, X-080-2101 · 08 KingsBox Landmine 3.0 | Article no: X-065-1010 · 09 Rig Landmine | For Royal or Mighty Rig | Article no: KB05RI-010, KB05MI-010 · 10 KingsBox Landmine 2.0 | Article no: X-065-1100 · 11 Rig Landmine | For Royal or Mighty Rig | Article no: KB05RI-010, KB05MI-010 · 12 KingsBox chain with buckle | 155CM/18mm | Article no: X-097-3120



DUMBBELLS

01



02



01 Quick Barbell Jack | Article no: KB09RI-011 · **02 KingsBox Quick Fit Barbell Jack** | Article no: X-064-4010 · **03 KingsBox Squat Ramp** | Article no: X-053-1800 · **04 KB Squat Ramp** | Article no: KB09RI-029 · **05 KingsBox Barbell Row Handle** | Fat grip | Article no: KB06RI-028 · **06 KingsBox Barbell Row Handle** | Slim | Article no: KB06RI-027



03



04

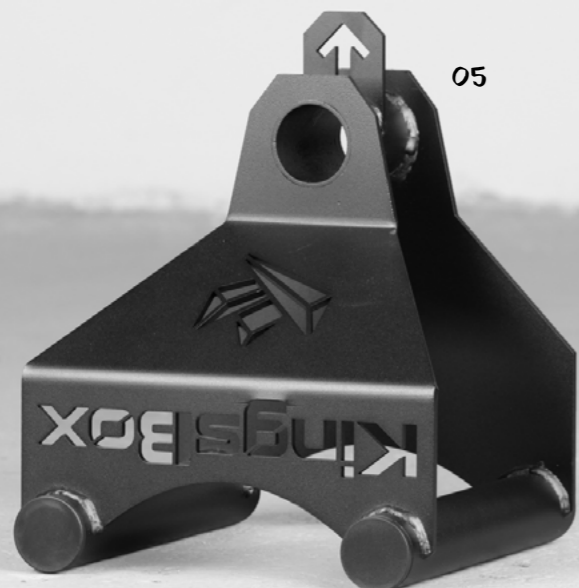

05



06

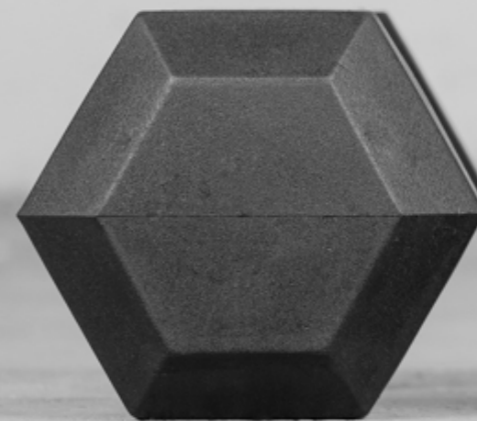

01

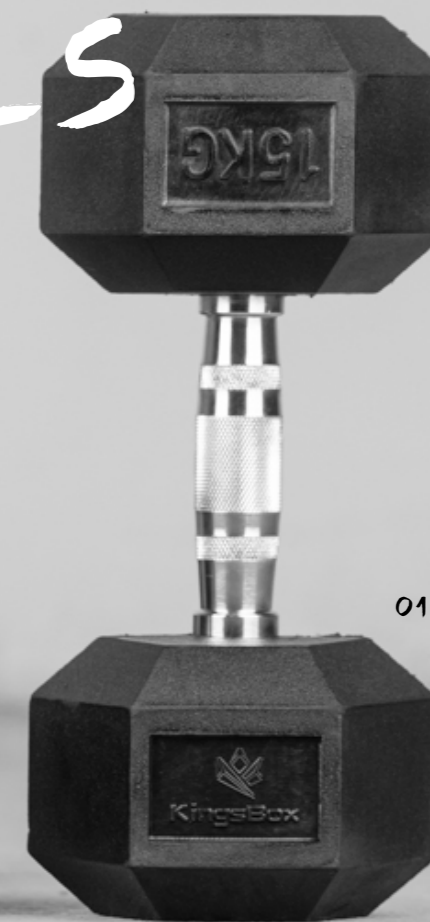

01 KingsBox Hex Dumbbells | 2kg, 5kg, 7kg, 10kg, 12.5kg, 15kg, 17.5kg, 20kg, 22.5kg, 25kg, 27.5kg, 30kg, 32kg, 32.5kg, 35kg, 37.5kg, 40kg, 42.5kg, 45kg, 47.5kg, 50kg | Article no: MA-010-0046 · **02 KingsBox Round Dumbbell** | 2.5kg, 5kg, 7.5kg, 10kg, 12.5kg, 15kg, 17.5kg, 20kg, 22.5kg, 25kg, 27.5kg, 30kg | Article no: X-040-1001, X-040-1101, X-040-1201, X-040-1301, X-040-1401, X-040-1501, X-040-1701, X-040-1801, X-040-1601, X-040-1901, X-040-2001, X-040-2101

02



KingsBox

20

DUMBBELLS

01 KingsBox Rubber Grip Dumbbells | 2.5kg, 5kg, 7.5kg, 10kg, 12.5kg, 15kg, 17.5kg, 20kg, 22.5kg, 25kg, 27.5kg, 30kg, 32.5kg, 35kg, 37.5kg, 40kg, | Article no: X-040-4100, X-040-4200, X-040-4300, X-040-4400, X-040-4500, X-040-4600, X-040-4700, X-040-4800, X-040-4900, X-040-5000, X-040-5100, X-040-5200, X-040-5300, X-040-5400, X-040-5500, X-040-5600 • **02 KingsBox Quick Fit Dumbbell** | 2kg, 4kg, 8kg, 12kg, 16kg, 20kg, 24kg, 28kg, 32kg | Article no: X-046-2000 • **03 KingsBox Olympic Dumbbell** | 5.5kg | Article no: X-046-1000 • **04 Axle Olympic Dumbbell** | 2.65kg | fat or slim | Article no: KB06RI-062 • **05 Dumbbell Handle Kit** | Article no: KB06RI-049 • **06 KingsBox Circuss Dumbbell** | 58kg | Article no: KB10-001 • **07 KingsBox Monster Dumbbell** | 35kg | Article no: X-046-1100



01



03



04



04



05



02



06



07

KETTLEBELLS



SUPREME
KETTLEBELL



COMPETITION
KETTLEBELL



RUBBER GRIP
KETTLEBELL



ADJUSTABLE
KETTLEBELL

01 KingsBox Competition Kettlebell | 8kg, 12kg, 16kg, 20kg, 24kg, 28kg, 32kg | Article no: MA-010-0052 • 02 KingsBox Kettlebell | 4kg, 6kg, 8kg, 10kg, 12kg, 16kg, 20kg, 24kg, 28kg, 32kg, 40kg | Article no: MA-010-0048 • 03 KingsBox Rubber Grip Kettlebell | 8kg, 12kg, 16kg, 24kg, 32kg | Article no: X-033-3000 • 04 KingsBox Adjustable Kettlebell | Article no: KB06RI-075

BALLS



01



01

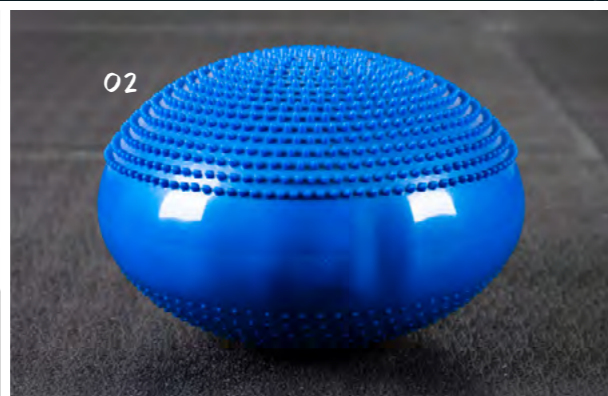

02



03

10



04



05

20 kg

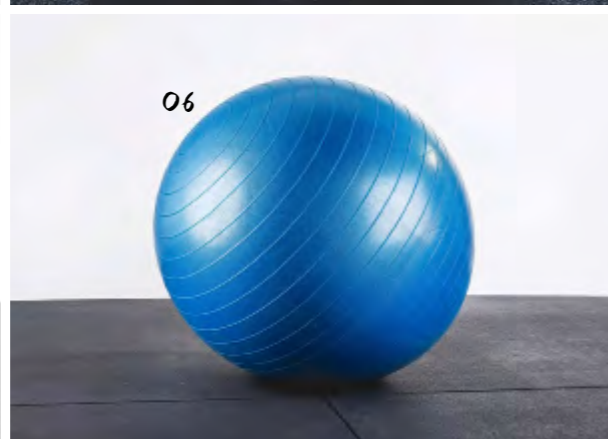

06

01 Easy Grip Slam Ball

I 4kg, 6kg, 8kg, 10kg, 12kg, 15kg, 20kg, 25kg, 30kg, 40kg, 50kg, 60kg I Article no: MA-010-0122

02 Small Half Yoga Ball

I Article no: X-084-3210

03 The Cannon Wall Ball

I 2kg, 4kg, 6kg, 9kg, 10kg, 12kg, 15kg I Article no: MA-010-0058

04 Half Yoga Ball I

Article no: X-084-3200

05 KingsBox Slam Ball I

MA-010-0044

06 Yoga Ball I

35cm, 65cm I Article no: X-084-3000, X-084-3100

07 Marmor Atlas Stone I

20kg, 30kg, 40kg, 60kg, 80kg, 110kg I Article no: MA-010-0066

08 Adjustable Sand Bag I

Article no: X-024-3000

09 KingsBox Ultimate Sand Bag I

45kg, 68kg, 90kg, 113kg, 135kg, 118kg I Article no: MA-010-0166

10 Banana Bag I

5kg, 6kg I Article no: X-028-1000, X-028-1100

11 KingsBox Sand Bags I

5kg, 10kg, 15kg, 20kg, 25kg, 30kg I Article no: MA-010-0032

12 KingsBox Walking Beam I

66kg I Article no: KB06RI-041



07



08



09



10



10



11



09

SANDBAGS & STONES

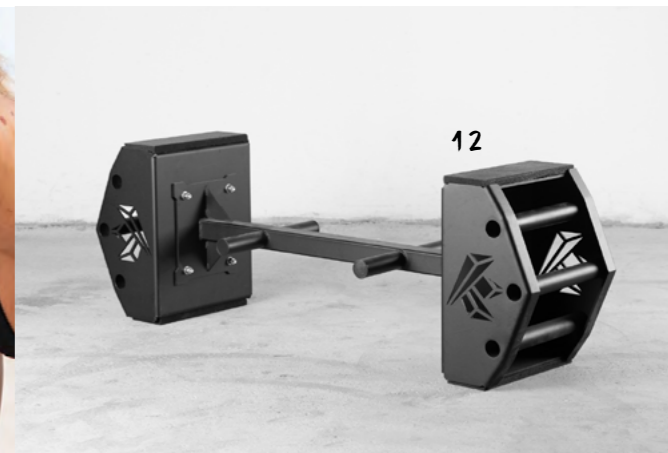

12

PLYO BOX & JERK BLOCKS



01 KingsBox Black Jerk Block | 6cm, 15cm, 30cm, 38cm | Article no: X-094-3100 • 02 Kingsbox Jerk Block | 6cm, 15cm, 30cm, 38cm | Article no: X-094-3000 • 03 KingsBox H-Thrust Block | Article no: X-094-2110 • 04 KingsBox Steel Jerk Blocks | 86-142cm x 100cm x 66cm | Article no: KB06RI-014 • 05 Kings Anti-Slip Plyo Box | 50cm x 60cm x 75cm | Article no: X-094-1200 • 06 Kings Plyo Box | 50cm x 60cm x 75cm | Article no: X-094-1000 • 07 Royal Plyo Box | 50cm x 60cm x 75cm | Article no: KB06RI-018 • 08 Royal Anti Slip Plyo Box | 50cm x 60cm x 75cm | Article no: KB06RI-018_AS • 09 KingsBox Pull Blocks | 52cm x 40cm | Article no: X-094-5000 • 10 Foam Plyo Box | 7.5cm, 15cm, 30cm, 45cm, 60cm | Article no: KX-094-2000 • 11 Soft Plyo Box - EVA Foam | 50cm x 60cm x 75cm | Article no: X-094-2100 • 12 KingsBox Plyo Box Mini | 35cm x 40cm | Article no: X-094-1300





01

VESTS



01



02



03



03



05



04

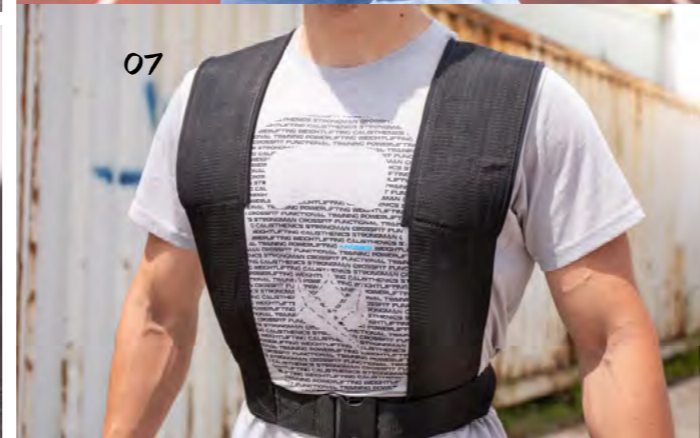

07



06

VESTS



01

02

03

01 Royal Motion Vest | Article no: X-093-2000 • 02 Starter Weighted Vest | Article no: X-093-1100 • 03 Elite Weighted Vest | Article no: X-093-1200 • 04 Classic Weighted Vest | Article no: X-093-1110 • 05 Royal Motion Plate | 3.8kg, 4.3kg | Article no: X-093-2100, X-093-2200 • 06 Weight Vest | 1kg | Article no: X-093-1000 • 07 KingsBox Sled Vest | Article no: X-073-5100 • 08 Resistance Training Straps | L Length 300cm | Article no: X-075-3400



08



JUMP ROPES



01



02



03



04



05



06



07

07



08



09



09

01 Royal Skipping Rope | Camo Wood, Camo Flame, Camo Arrow, Camo Army | Article no: MA-010-0164 • 02 Triple Under Jump Rope | Blue, Red | Article no: MA-010-0071 • 03 KingsBox Aluminium Jump Rope | Black, Pink, Blue | Article no: MA-010-0025 • 04 KingsBox Precision Jump Rope | Black, Blue | Article no: MA-010-0159 • 05 PRO spare Jump rope cord | Gray | Article no: X-070-9031 • 06 Spare Cord for the Jump Rope | Blue, Black | Article no: MA-010-0194 • 07 KingsBox Jump Rope | Blue, Black | Article no: MA-010-0041 • 08 KingsBox Skipping Rope | Blue | Article no: X-070-1500 • 09 KingsBox Heavy Speed Rope | Article no: X-070-1100

SUSPENSION TRAINING & ROPES

01 Kings Climbing Rope | 3m, 4.5m, 6m, 12m | Article no: MA-010-0053 • 02 Royal Battle Rope | 12m | Article no: X-074-2100 • 03 KingsBox Wooden Gymnastic Rings | Article no: X-075-1000 • 04 Adjustable straps for Gymnastic Rings | Article no: X-075-1900 • 05 KingsBox Battle Rope | 25mm X 12m | Article no: X-074-2200 • 06 KingsBox Black Rings | Plastic | Article no: X-075-11000 • 07 KingsBox Powerstraps | Article no: X-084-3300 • 08 Royal Branch Wall Bracket | Article no: 5111000 • 09 KingsBox Climbing Net | Article no: X-074-3000 • 10 KingsBox Ceiling Hanger | Article no: X-060-2240 • 11 KingsBox Ring/ Rope Hanger | Article no: X-060-2260 • 12 KingsBox Ring Vest Hacker | Article no: X-093-4001



01



04



07



10



08



11



02



05



09



12



03



06



01

01 KingsBox Ab Blasters | Article no: X-083-3000 • 02 KingsBox Supersonic Rope | Article no: X-230-0000 • 03 KingsBox Start up Strap | Article no: X-235-0100

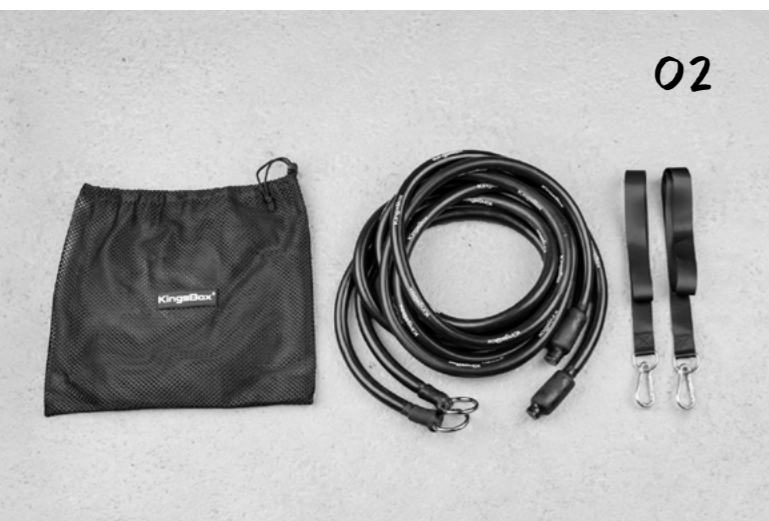

02

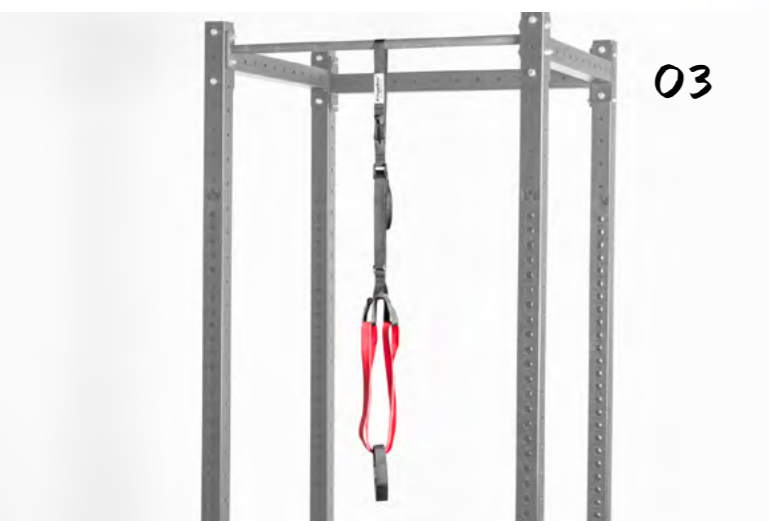

03



KINGSBOX

KingsBox

KingsBox

KingsBox



01



02



03



04



05

01 KingsBox Yoga Mat | Black, Pink, Blue, | Article no: MA-010-0020 • Kings Box Yoga Mat PRO | Black, Pink, Blue, | Article no: MA-010-0273 • 03 KingsBox AB Mat | Article no: X-095-1200 • 04 KingsBox HandStand Mat | Article no: X-095-1220 • 05 KingsBox Long AB Mat | Article no: X-095-1210 • 06 KingsBox Mat | Article no: X-095-1000 • 07 KingsBox Foam Training Pad | Article no: X-084-3220 • 08 KingsBox Fat Mat | Article no: X-095-1300



06

MATS

FOR SAVING YOUR BUTT



07



08

3 IN 1

SEMI GRIP



09

SLIM GRIP



FAT GRIP



10

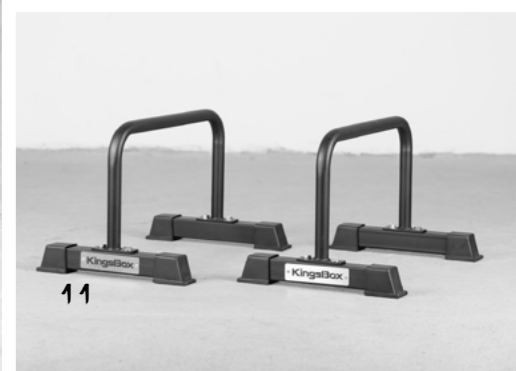

11

PARALLETTES

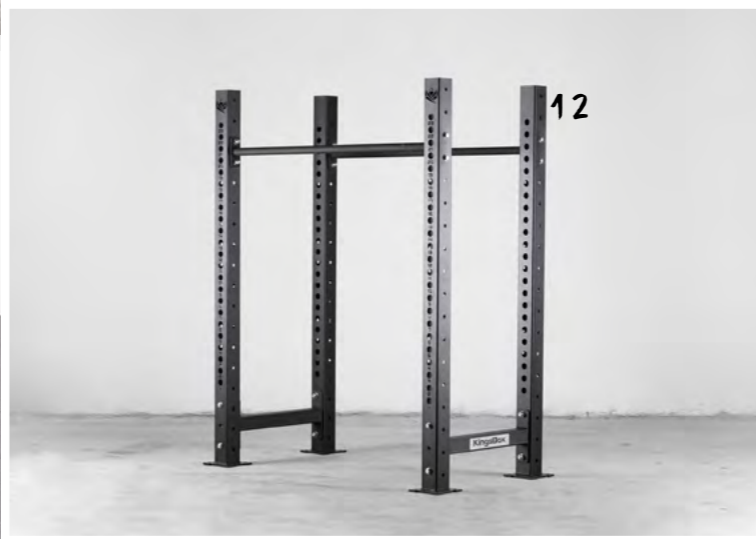

12



10

09 Royal Parallettes | Article no: KB06RI-001 • 10 High VR Parallettes | Article no: KB06RI-022 • 11 KingsBox Parallettes VR | Article no: X-096-1000 • 12 KingsBox Mighty Parallettes | Article no: KB06MI-005



CLUBBELLS & HAMMERS



01 KingsBox Macebell Hammer | 2kg, 4kg, 6kg, 8kg, 10kg, 15kg, 20kg, 20kg, 25kg, 30kg | Article no: MA-010-0119 • 02 Knight Hammer | 4kg, 6kg, 8kg, 10kg, 15kg, 20kg, 20kg, 25kg, 30kg | Article no: MA-010-0039 • 03 KingsBox Steel Clubbell | 2kg, 4kg, 6kg, 8kg, 10kg, 15kg, 20kg, 20kg | Article no: MA-010-0043



CHOOSE YOUR WEAPON



HURDLES

04 8m Agility Scale | Article no: X-075-3000 • 05 KingsBox Low Hurdles | Article no: X-075-3300 • 06 KingsBox Handstand Walk Platform | Article no: X-095-1400





**ROYAL
FAMILY**

FOR MORE VISIT

<https://www.kingsbox.it/en/royal-family-2/>

At KingsBox, we
consider our
members to be
family.

**MORE THAN
200 GYMS IN
OUR FAMILY**

BENCHES



01 Royal Hip Thruster | Article no: KB06RI-026 · 02 Mighty Flat Bench | Thick Pillow, Fat Pillow | Article no: MA-010-0222 · 03 Royal Flat Bench | Article no: KB06RI-005 · 04 KingsBox Flat Bench | Article no: X-062-1000 · 05 KingsBox Adjustable Bench | Article no: X-062-2000 · 06 Royal Adjustable Bench | Article no: KB06RI-003 · 07 Fat Pillow | Article no: X-062-9100 · 08 KingsBox Combo PL Bench | Article no: X-096-4000 · 09 Ultimate Adjustable Bench | Article no: KB06RI-017

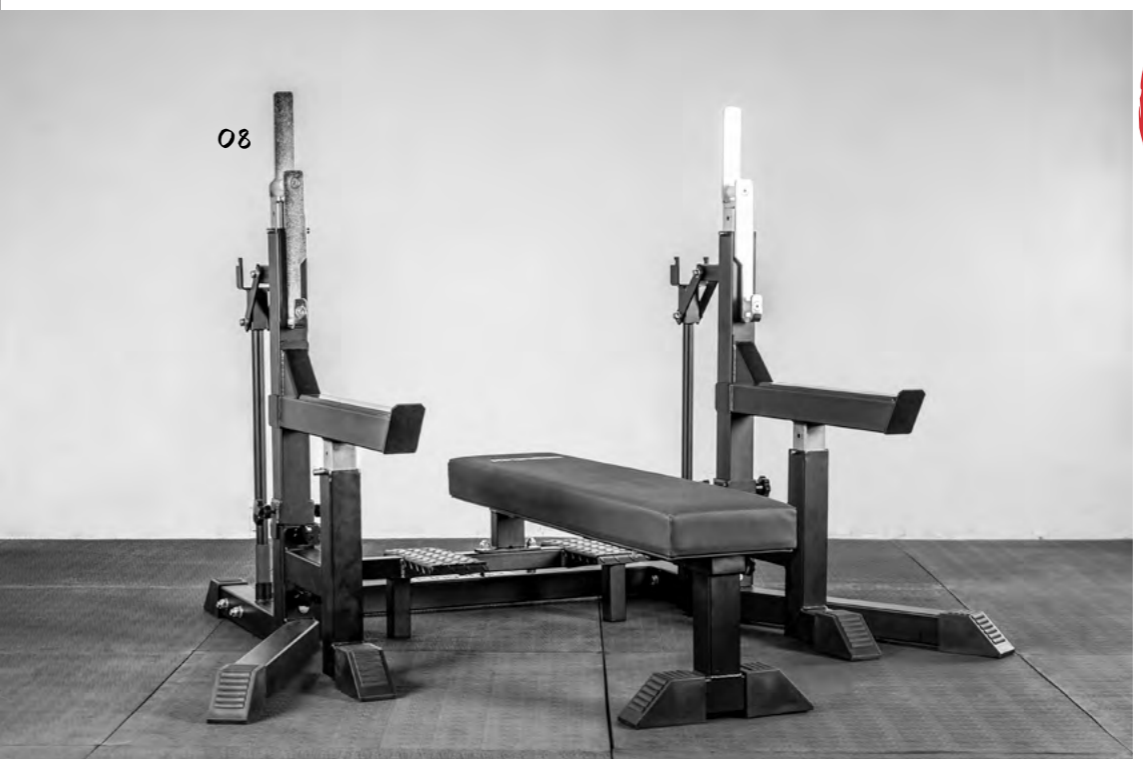



01 Foldable Flat Bench I Article no: KB06RI-047 • **02 FFB Wall Carrier I** Article no: 4639000 • **03 Royal Rowing Bench I** Article no: KB06RI-058 • **04 Mighty QF Leg Holder I** Article no: 4613000

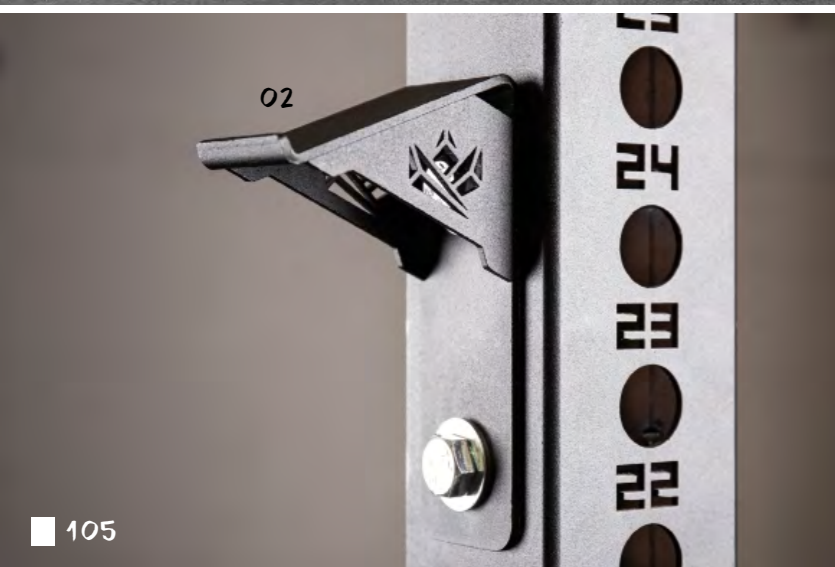



01

01 KingsBox Rowing Bench | Article no: KX-096-5100 • **02 Royal Hip Thruster** | Article no: KB06RI-026



02

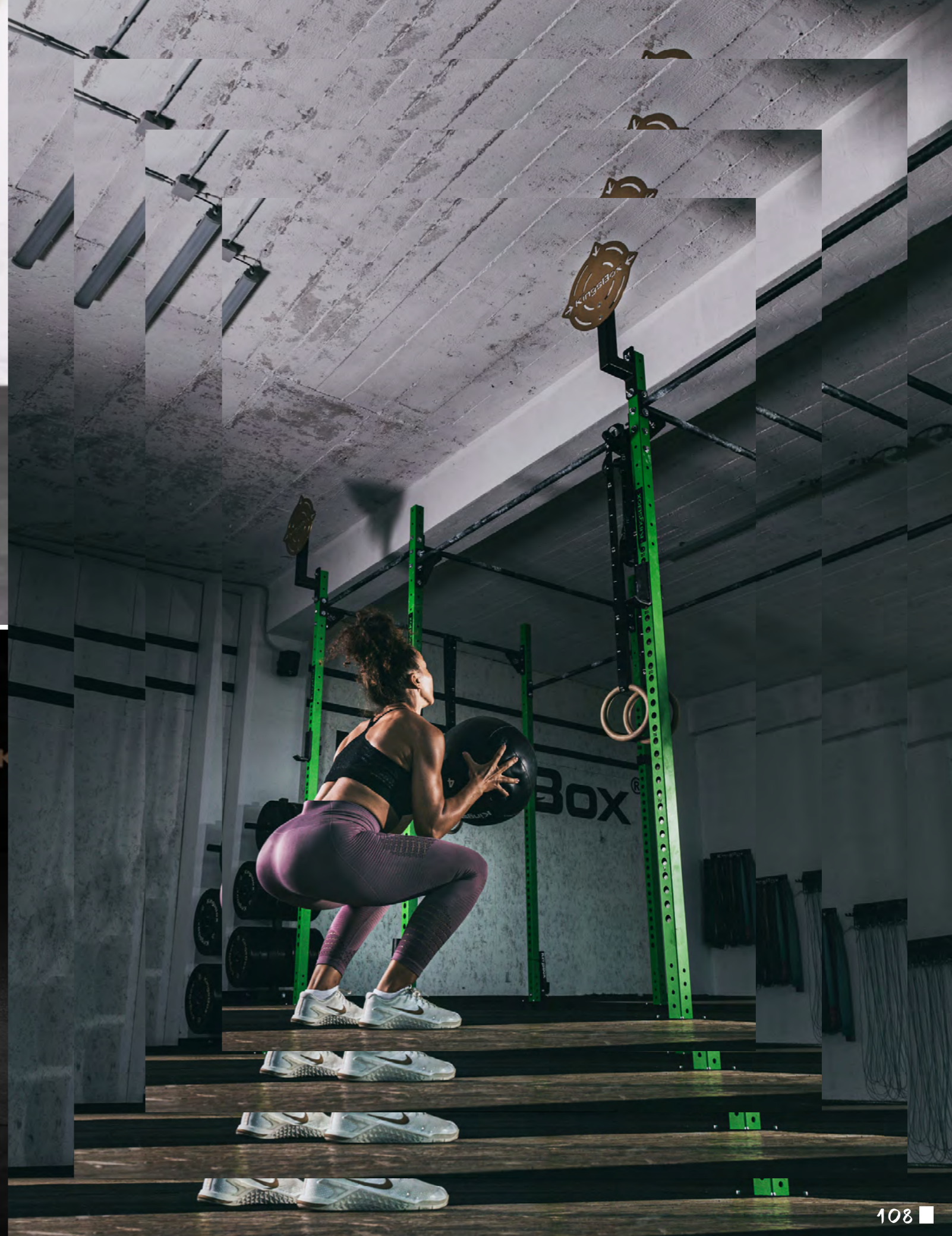

SLEDS & GHD

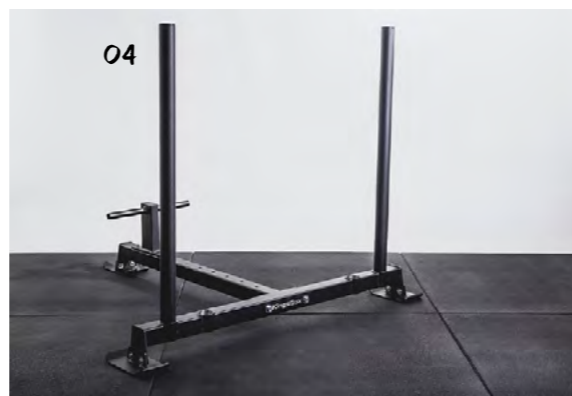

01 KingsBox Glute Ham Roller (GHR) | Article no: X-096-3000 • 02 Royal Sled 1.0 | Article no: X-073-1000 • 03 Pull Sled | Article no: 5172000 • 04 Royal Prowler Sled 2.0 | Article no: X-073-2100 • 05 Royal Sled 2.0 | Article no: X-073-1100

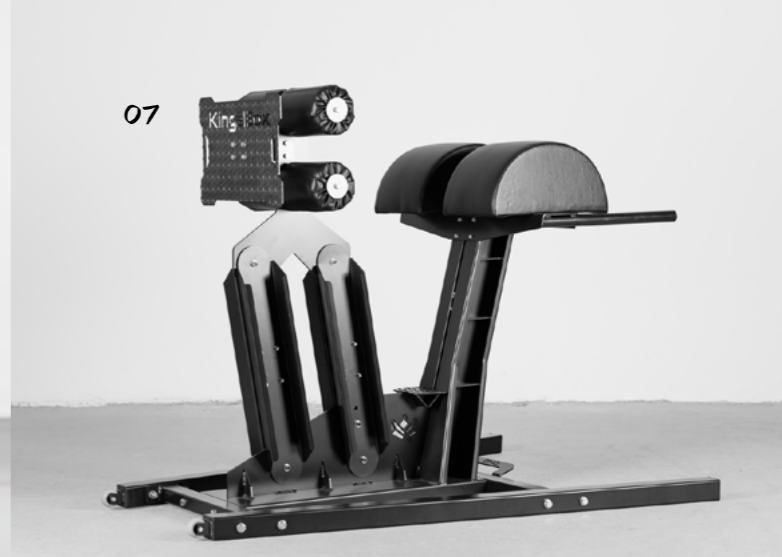

06 KingsBox Fortified GHD | Article no: KX-096-3000 • 07 Mighty GHD | Article no: KB06RI-012 • 08 The Empire GHD | Article no: X-096-2000 • 09 Royal GHD | Article no: KB06RI-011 • 10 KingsBox Sissy Squat Trainer | Article no: X-096-5000

REVERSE HYPER

01



03



02



04



01 KingsBox Reverse Hyper 1.0 I
Article no: X-096-4110 • **02 Foldable**
Reverse Hyper I Article no: KB07RI-012
• **03 Reverse Hyper Rig Attachment**
I Article no: KB05RI-039 • **04 Royal**
Reverse Hyper I Article no: KB06RI-066

YOKE & CARRY GEAR

01



01 **Mighty Yoke MX-45** | Article no: KB04MI-017 · 02 **Royal Yoke MX-40** | Article no: KB04RI-016 · 03 **Royal Yoke MX-45** | Article no: KB04RI-015 · 04 **Royal or Mighty Yoke SX to Yoke Kit** | Article no: KB05RI-032, KB05MI-029 · 05 **Mighty Yoke MX-40** | Article no: KB04MI-016

01



02



03



04



05





01 KingsBox Free Yoke | Article no: KB06RI-013 • 02 KingsBox Tower Farmer Handles | Article no: KB06RI-020 • 03 KingsBox Farmer Walk Handles | Article no: X-011-1110 • 04 Farmer Walk Handles 2.0 | Article no: KB06RI-053



CARDIO MACHINES



**ASSAULT
FITNESS**



**XEBEX
FITNESS**



06 Assault Bike | Article no: X-072-1600 • **07 Assault Runner** | Article no: X-072-2002 • **08 Assault Wind Screen** | Article no: X-072-1601 • **09 Assault Airrower Elite** | Article no: X-072-2003 • **10 Assault Airbike Elite** | Article no: X-072-1605 • **11 Xebex Air Rower 2.0** | Article no: X-072-1351 • **12 Xebex Air Rower 3.0** | Article no: X-072-1350

01 Royal Air Rower | Article no: X-072-1314 • **02 Royal Runner 2.0** | Article no: X-072-3001 • **03 Concept 2 BikeErg** | Article no: X-072-1500 • **04 Concept 2 SkiErg** | Article no: X-072-1200 • **05 Concept 2 SkiErg Floor Stand** | Article no: X-072-1400 • **06 Concept 2 model D ROWER - PM 5** | Article no: X-072-1000 • **07 Concept 2 model E ROWER - PM 5** | Article no: X-072-1100 •



STORAGE

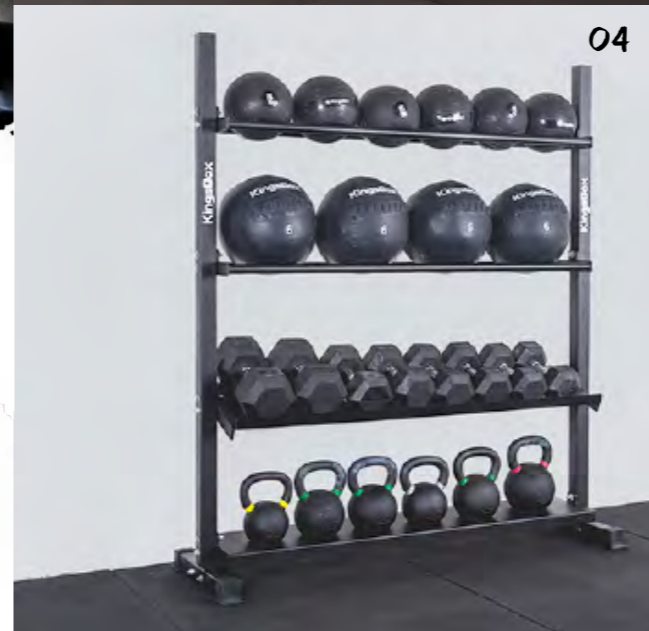

01 Three Shelf Multistorage | Article no: MA-010-0177
 02 Kettlebell Rack | Article no: MA-010-0050 • 03 Adjustable Multistorage | Article no: MA-010-0223 • 04 Multi Storage Rack | Article no: MA-010-0042 • 05 Castle Vertical Plate Tree | Article no: KB08RI-004 • 06 Dumbbell Rack | Article no: X-061-2000 • 07 Wall Ball Wall Shelf | Article no: X-061-5000 • 08 KingsBox Tower Weight Rack | Article no: X-061-1000



4
O
P
T
I
O
N
S

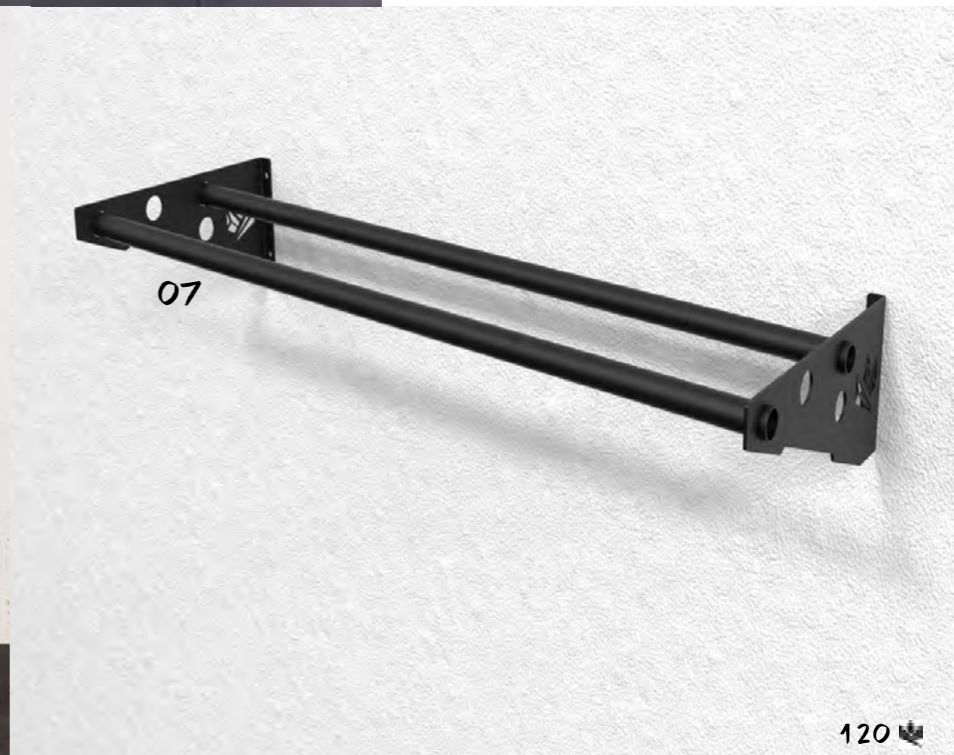

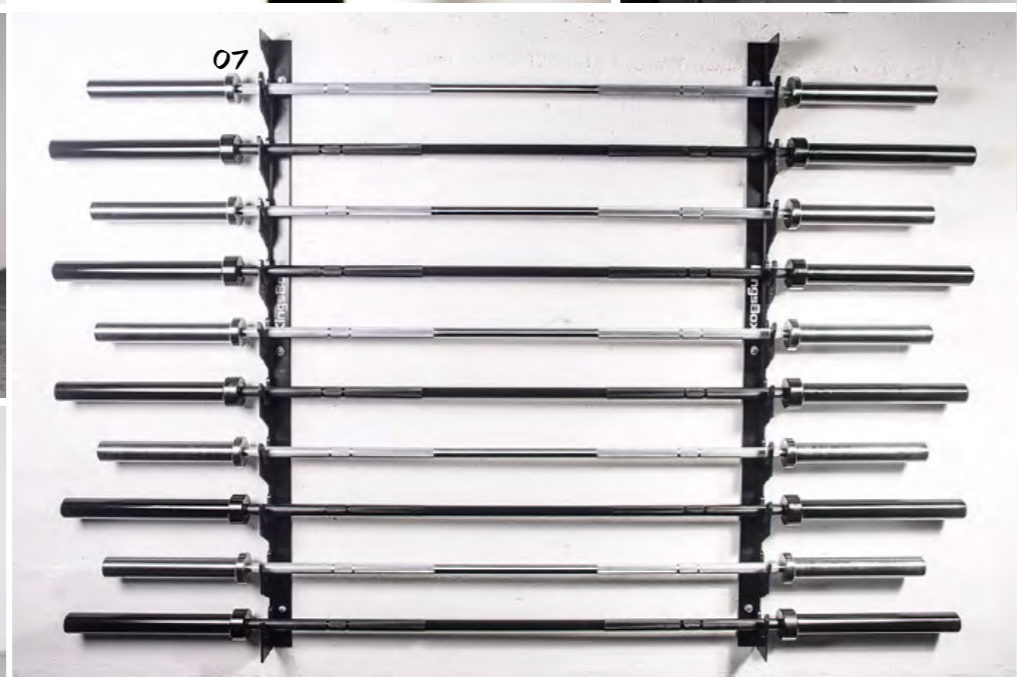
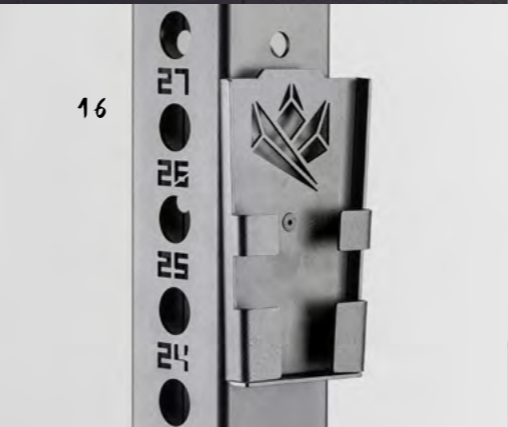
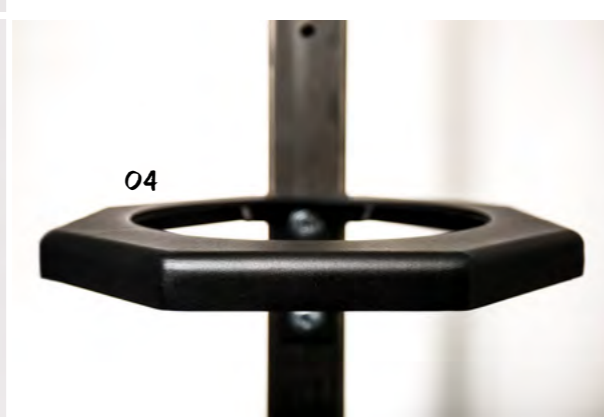

01 Sword Wall Barbell Vertical Rack I | Article no: X-060-2200 • **02 Wall Barbell Blocker I** | Article no: 6205000 • **03 Sand Bag Wall Shelf I** | Article no: 5245000 • **04 Wall Ball Wall Shelf I** | Article no: X-061-5000 • **05 Multi Storage Hanger I** | Article no: 6214000 • **06 Bridge Barbell Rack II. I** | Article no: KB08RI-011 • **07 Horizontal Rack for Barbells Gate I** for 6 or 10 bars | Article no: MA-010-0040 • **08 KingsBox Linear Barbell Rack I** | Article no: KB08MI-006 • **09 Mortar Bumper Rack I** Royal or Mighty | Article no: KB05RI-021, KB05MI-009 • **10 Space-saving Hook I** Royal or Mighty | Article no: KB05RI-046, KB05MI-049 • **11 Eagle Rack for Barbells and Bumpers I** | Article no: X-060-2230 • **12 KingsBox Magnesium Container 1.0 I** | Article no: X-087-2000 • **13 Wall Magnesium Bowl Support I** | Article no: KB07RI-004 • **14 Royal Magnesium Container 2.0 I** | Article no: X-065-5100 • **15 Wall Jump Rope Hanger I** | Article no: 6211000 • **16 Telephone Support I** | Article no: MA-010-0105 • **17 Barbell Rack I** Royal or Mighty | Article no: KB05RI-023, KB05MI-011 • **18 Mini Shelf I** Royal or Mighty | Article no: KB05RI-044, KB05MI-047 • **19 KingsBox Multi-use Hanger I** | Article no: 6203000 • **20 Hook for Rower or Bench I** | Article no: 6111000 • **21 KingsBox Bumper Spacer I** | Article no: KB09RI-010



01

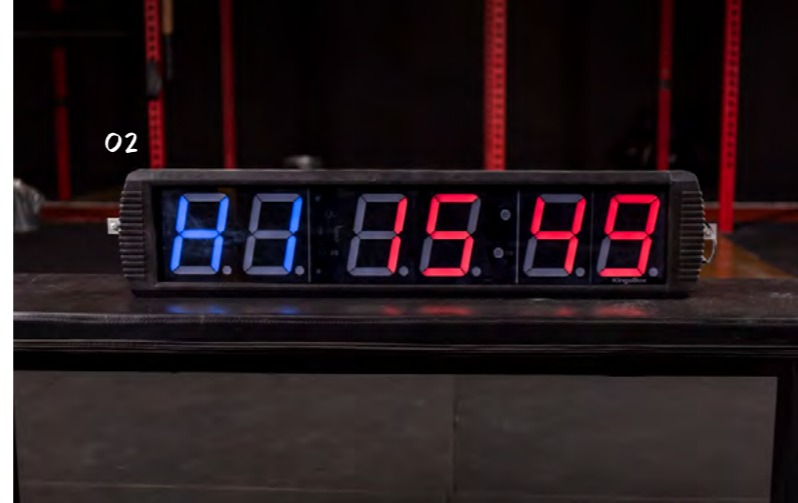

02



08

WHITEBOARDS & FURNITURE

08 Magnetic Gym Whiteboard | Article no: KB06RI-064 • **09 KingsBox Glass Board** | Black or white | Article no: X-097-7020, X-097-7010 • **10 KingsBox Whiteboard** | Article no: X-097-7000 • **11 Kingsbox Chair** | Article no: KB13RI-002 • **12 Kingsbox Mighty Reception Desk** | Article no: KB13RI-003 • **13 KingsBox Locker Room Bench** | Article no: KB13RI-001



03

TIMERS

01 Royal Timer | Article no: X-097-2100 • **02 Cross Timer** | Article no: X-097-2000 • **03 KingsBox Home Gym Timer** | Article no: X-097-2200 • **04 Remote Control for Digital Timer** | Article no: X-097-2500 • **05 KingsBox Smart Home Timer** | Article no: X-097-2220 • **06 Kingsbox Magnetic Timer** | Article no: X-097-2210 • **07 Kingsbox Market Holder** | Article no: KB05RI-093



09



09



04



05



10



11



06

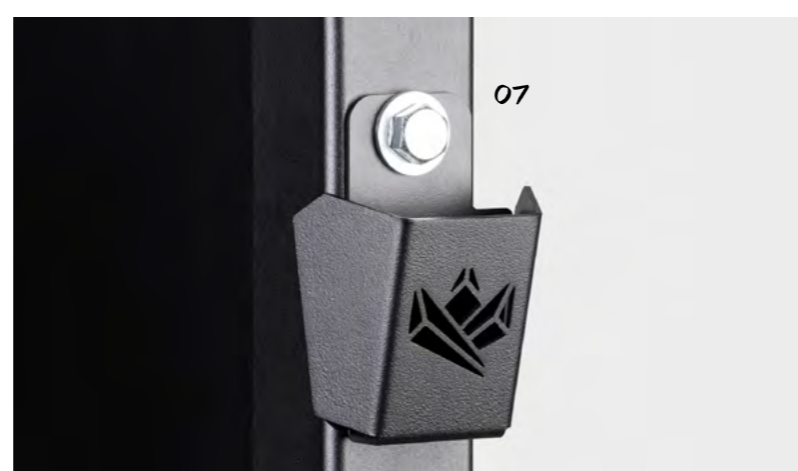

07



12



13

FLOORING



01

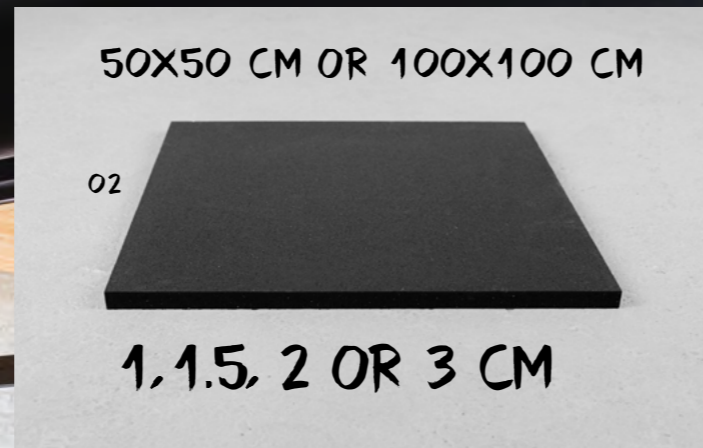

50X50 CM OR 100X100 CM

02

1, 1.5, 2 OR 3 CM



03

100X100 CM

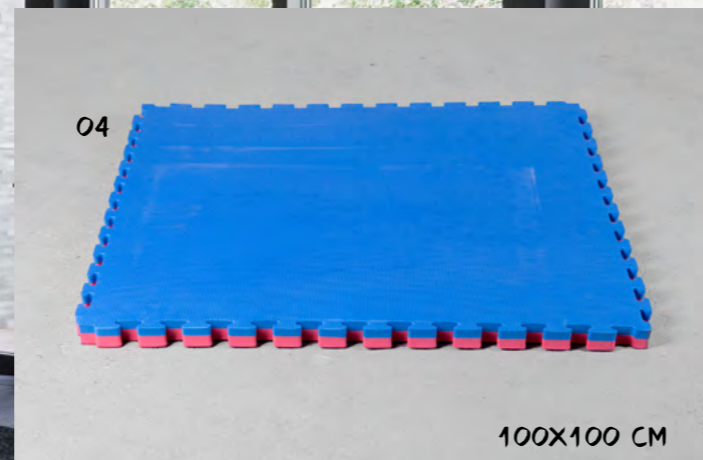

04

100X100 CM



05



06



07

TOURNAMENT PLATFORM



08

WITH WOOD



09

WITHOUT WOOD

01 KingsBox Puzzle Grass Flooring | 30x30cm, green | Article no: X-052-2010 • 02 Royal Rubber Floor | 50x50cm (2cm, 3 cm), 100x100cm (1.5cm, 2cm, 3cm) | Article no: X-050-3210, X-050-3400, X-050-3510, X-050-3610, X-050-3800 • 03 KingsBox Anti-Vibration Foam | 100x100cm (4cm) | Article no: X-051-9000 • 04 Tatami Puzzle | 100x100cm (4cm) | Article no: X-054-1000 • 05 KingsBox Shield | Article no: X-095-1100 • 06 Finishing Molding | 100cm (10mm, 15mm, 20mm, 30mm, 40mm) | Article no: 9608000, 9614000, 9609000, 9610000, 9611000 • 07 Sprintrack | Article no: ST-C-200-1000 • 08 KingsBox Tournament Lifting Platform | 200x300cm | with wood | Article no: KB06RI-023 • 09 KingsBox Tournament Lifting Platform | 200x300cm | without wood | Article no: KB06RI-025

MOBILITY

01 KingsBox Elastic Bands I 6.4mm, 13mm, 21mm, 29mm, 45mm, 64mm | Article no: MA-010-0061 • **02 KingsBox Short Elastics I** 0.8mm, 1mm, 1.1mm, 1.2mm | Article no: MA-010-0012 • **03 Matix Massage Accessory I** Article no: X-084-1100 • **04 Double Lacrosse Ball I** black, blue | Article no: MA-010-0120 • **05 KingsBox Lacrosse Ball I** Article no: X-084-1200 • **06 Kings Mobility Ball I** Article no: X-084-1300 • **07 KingsBox Spiky Massage Ball I** Article no: X-084-1210 • **08 KingsBox Home Mobility Sphered I** Article no: X-084-1310 • **09 KingsBox Eva Yoga Block I** Article no: X-084-2100 • **10 KingsBox Trigger Breaker I** black, blue, pink | Article no: MA-010-0123 • **11 KingsBox EVA Foam Roller I** black, pink-blue, green-yellow, brown-blue, blue-green | Article no: MA-010-0030 • **12 KingsBox Floss Band I** Article no: X-084-1400 • **13 KingsBox Symmetry Mobility Tool I** Article no: X-084-6010

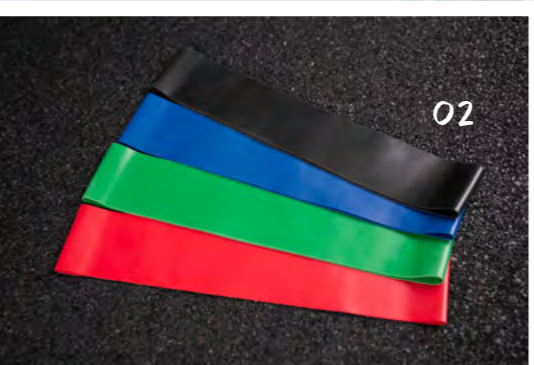

ACCESSORIES

01 KingsBox Squat Belt | Article no: X-084-4450 • 02 ARMOR Leather Bealt | S,M,L,XL | Article no: MA-010-0002 • 03 Fluo Bite | Article no: X-089-1000
• 04 KingsBox Knee Sleeves Blue | XS,S,M,L,XL | Article no: MA-010-0001 • 05 KingsBox Knee Sleeves Blue/red | S,M,L,XL | Article no: MA-010-0001 •
06 ARMOR Dip Belt | Article no: X-084-4400 • 07 ARMOR Wrist Wraps | Article no: X-088-1100 • 08 Armor Lifting Straps | Article no: X-084-4200 • 09
KingsBox Weightlifting Straps | Article no: X-084-4210 • 10 Quick Fit ARMOR Belt | Article no: X-084-4110 • 11 KingsBox Nylon Lifting Belt | Article
no: X-084-4111 • 12 KingsBox Squat Belt made in EU | Article no: 9522000

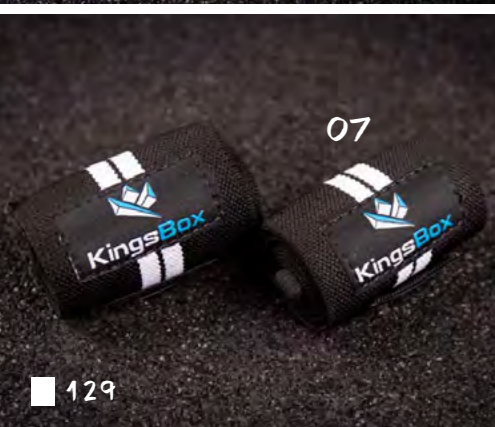
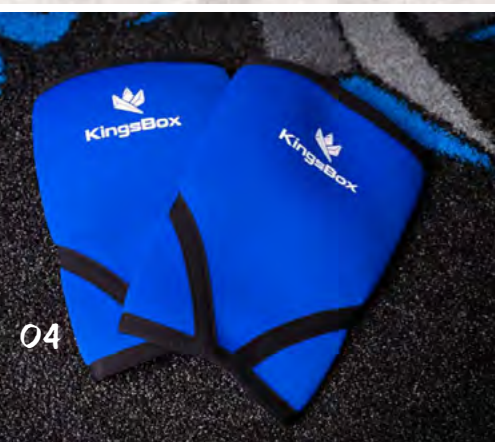

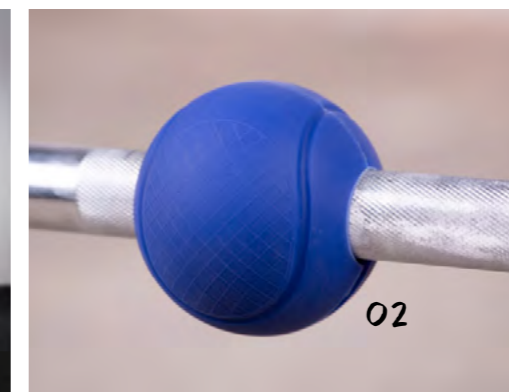

01 KingsBox Magnesium | Article no: X-087-2000 • **02 Spherical Grip for Barbell** | Article no: X-084-5000 • **03 Tubular Grip for Barbell** | Article no: X-084-5100 • **04 KingsBox Sticky Tape** | Article no: X-087-1000 • **05 Leather Strap for Palm** | S,M,L | Article no: MA-010-0118 • **06 Aluminum Grippers** | 40kg, 140kg | Article no: X-097-3310, X-097-3300 • **07 KingsBox Liquid Magnesium** | 200ml | Article no: X-087-2100 • **08 Handle 360** | Article no: KB06RI-042 • **09 KingsBox Barbell Pad** | Article no: X-062-9350 • **10 Wooden Cone Grip** | Article no: KB06RI-048





Do you want to become a KingsBox Athlete?

Send us your CV!
We would love to hear your story!

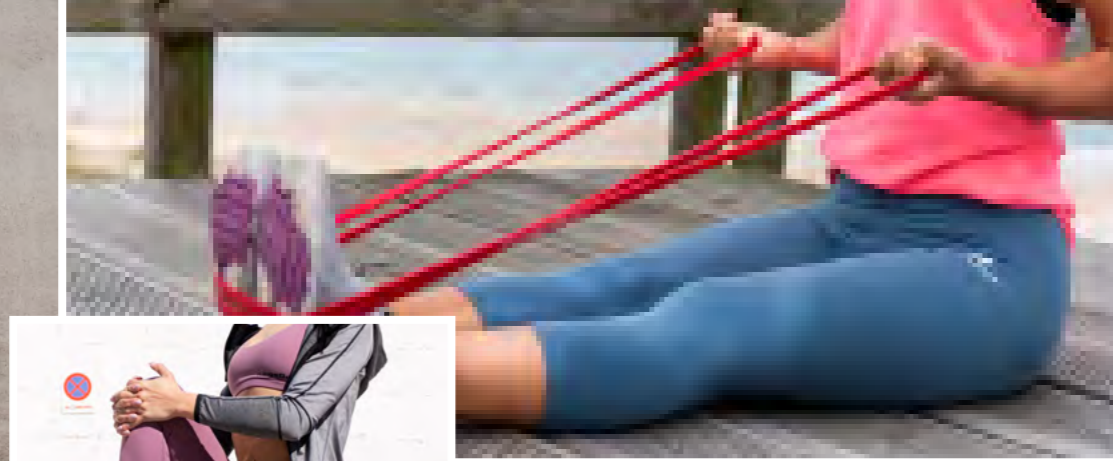

WOMEN'S LEGGING

Comfort counts



KINGSBOX CLASSIC LEGGING

Size: Xs, S, M, L, XL
Color: Pink, Black, Blue, Mystery Green
Composition: 80% Nylon, 20% Elastane
SKU: MA-010-0206

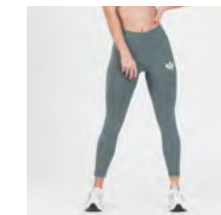

MADE FOR ATHLETES

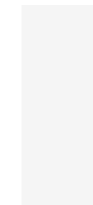

KINGSBOX CLASSIC SIDEPACK LEGGING

Size: Xs, S, M, L, XL
Color: Green, Black, Violet
Composition: 80% Nylon, 20% Spandex
SKU: MA-010-0457

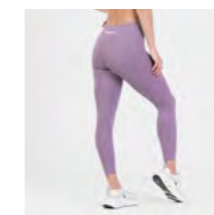

WOMEN'S TRAINING PANTS

Comfort counts



KINGSBOX LINE LEGGING

Size: Xs, S, M, L, XL
Composition: 80% Nylon, 20% Spandex
SKU: MA-010-0364



KINGSBOX CLASSIC GREY SPAN LEGGINGS

Size: Xs, S, M, L, XL
Composition: 80% Nylon, 20% Spandex
SKU: MA-010-0464

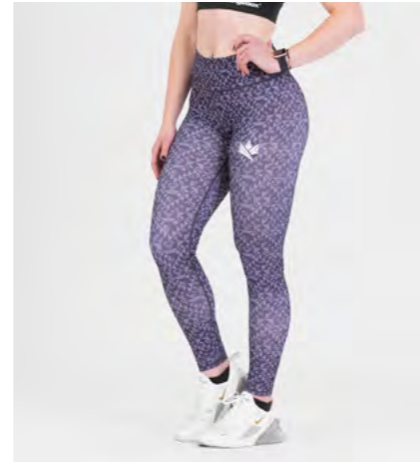

KINGSBOX CLASSIC 3FIT LEGGINGS

Size: Xs, S, M, L, XL
Composition: 80% Nylon, 20% Spandex
SKU: MA-010-0463



KINGSBOX WOMENS BAGGY TRAINING PANTS

Size: Xs, S, M, L, XL
Color: Black
Composition: 50% Cotton, 50% Polyester
SKU: MA-030-3001



KINGSBOX WOMENS TIGHT TRAINING PANTS

Size: S, M, L, XL
Composition: 50% Cotton, 50% Polyester
SKU: OB-030-3101



KINGSBOX CLASSIC SLIM GROW LEGGINGS

Size: Xs, S, M, L, XL
Warranty: 15 Days
Composition: 90% Nylon, 10% Spandex
SKU: MA-010-0460

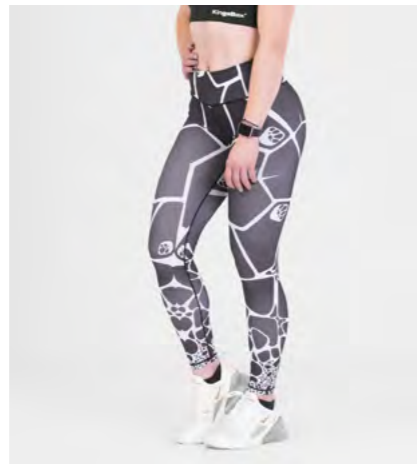

KINGSBOX CLASSIC WHITE-WEB LEGGINGS

Size: Xs, S, M, L, XL
Composition: 90% Nylon, 10% Spandex
SKU: MA-010-0461



KINGSBOX WOMENS TRAINING PANTS

Size: S, M, L, XL
Color: Black
Composition: 95% Nylon, 5% Elastane
SKU: OB-030-2800



WOMEN'S SHORTS

Comfort counts



KINGSBOX WOMENS FREEDOM SHORTS

Size: Xs, S, M, L, XL
Color: Violet, Black, Blue, Green
Warranty: 15 Days
Composition: 80% Nylon, 20% Spandex
SKU: OB-050-1330



KINGSBOX WOMENS CLASSIC SHORTS

Size: Xs, S, M, L, XL
Color: Pink, Black, Blue, Red
Warranty: 15 Days
Composition: 87% Nylon, 13% Elastane
SKU: OB-050-1000

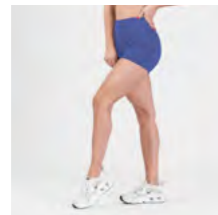
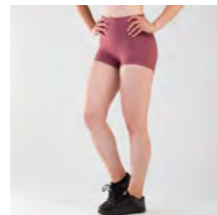

WOMEN'S BOOTY SHORTS

Size: Xs, S, M, L, XL
Color: Grey- Red, Alps White, Black, Green
Warranty: 15 Days
Composition: 87% Nylon, 13% Elastane
SKU: OB-050-1200

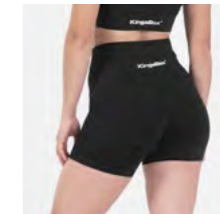
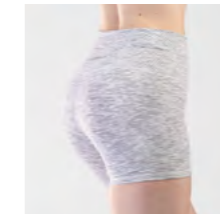
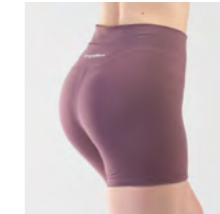

KINGSBOX WOMENS WORKOUT SHORTS

Size: Xs, S, M, L, XL
Color: Black
Warranty: 15 Days
Composition: 87% Nylon, 13% Elastane
SKU: OB-050-1400



WOMEN'S BRAS

Comfort counts

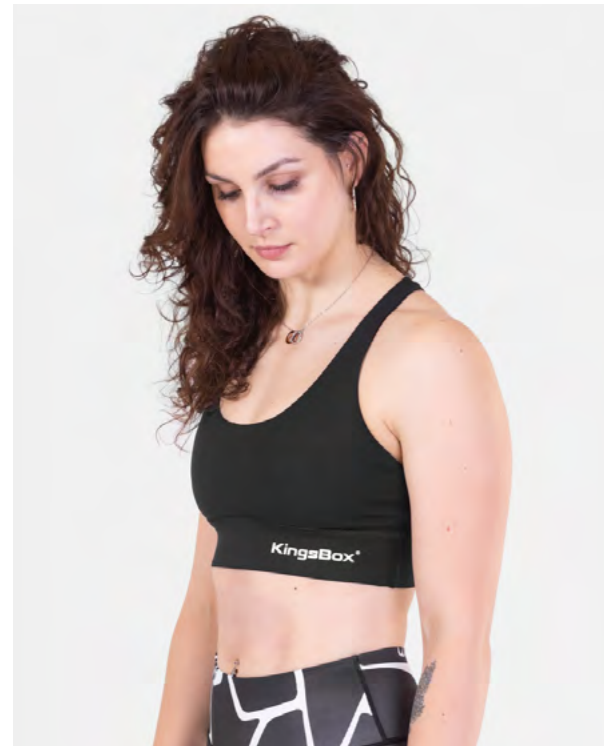

KINGSBOX HIGH SUPPORT BRA

Size: Xs, S, M, L, XL
Color: Black, Green
SKU: OB-070-1700

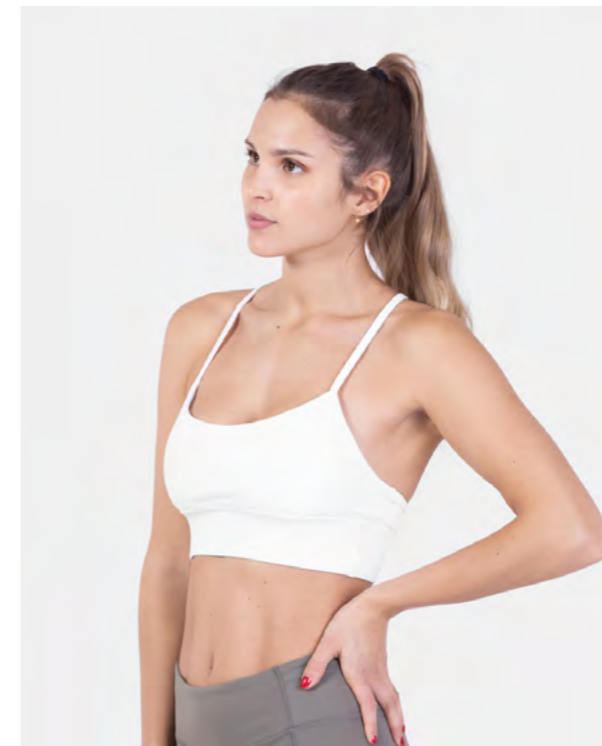

KINGSBOX DOUBLE STRAPPY BRA

Size: Xs, S, M, L, XL
Color: Black, White, Green, Blue, Pink
Composition: 80 % Nylon, 20 % Spandex
SKU: OB-070-1600



KINGSBOX CROSS STRAPPY BRA

Size: Xs, S, M, L, XL
Color: White, Blue, Black, Green
SKU: OB-070-1800



KINGSBOX CROSSBACK BRA

Size: Xs, S, M, L, XL
Composition: 80 % Nylon, 20 % Spandex
SKU: OB-070-1300

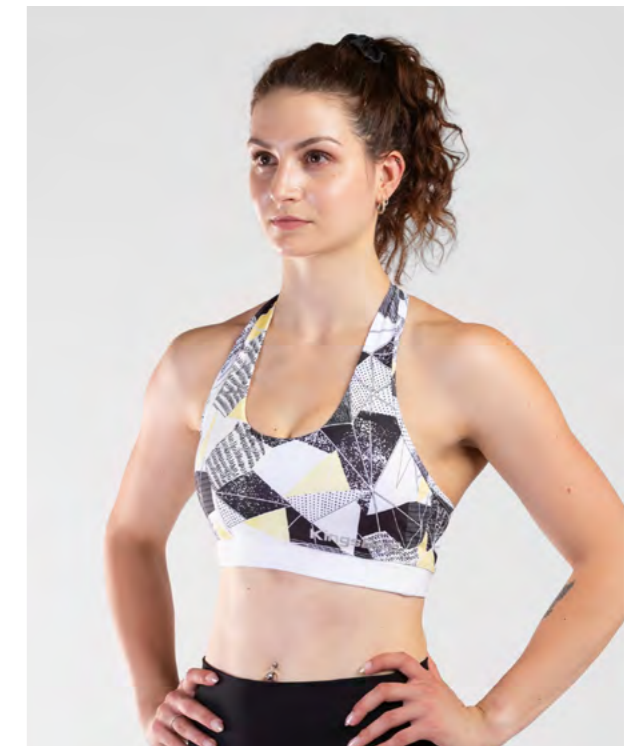

KINGSBOX SLIM STRIPE BRA

Size: Xs, S, M, L, XL
Composition: 80 % Nylon, 20 % Spandex
SKU: OB-070-1401





KINGSBOX DOUBLE STRAPPY BRA

Size: Xs, S, M, L, XL
Color: Black, White, Green, Blue, Pink
Composition: 80 % Nylon, 20 % Spandex
SKU: OB-070-1600



KINGSBOX CROSSBACK BRA

Size: Xs, S, M, L, XL
Composition: 80 % Nylon, 20 % Spandex
SKU: OB-070-1300



KINGSBOX SLIM STRIPE BRA

Size: Xs, S, M, L, XL
Composition: 80 % Nylon, 20 % Spandex
SKU: OB-070-1401



WOMEN'S TOPS

Comfort counts

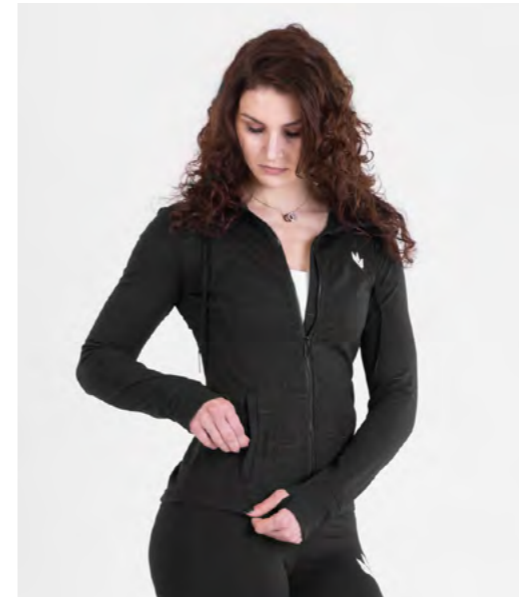

WOMENS ZIP-UP SPORT JACKET

Size: Xs, S, M, L, XL
Color: Black
Composition: 87 % Nylon, 13 % Elastane
SKU: OB-060-1300

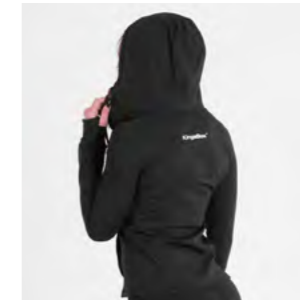

WOMENS WHITE ZIP-UP

Size: S, M, L
Color: White
Composition: 87 % Nylon, 13 % Elastane
SKU: OB-060-1201

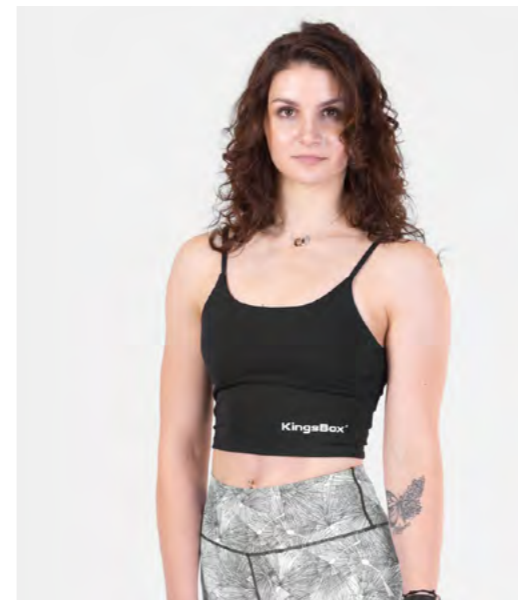

WOMENS CROP TANK TOP

Size: Xs, S, M, L, XL
Color: White
SKU: OB-040-1301

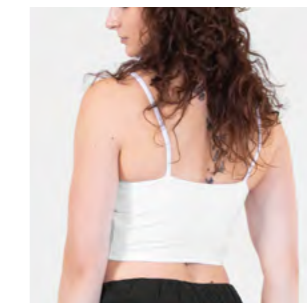

MEN'S

Comfort counts



KINGSBOX BLOOD T-SHIRT

Size: Xs, S, M, L, XL, XXL
Color: Black
Composition: 100% Cotton
SKU: OB-010-8100-



CLASSIC KINGSBOX T-SHIRT

Size: S, M, L, XL
Color: Black
Composition: 100% Cotton
SKU: OB-010-5000-



WOMENS ZIP-UP SPORT JACKET

Size: Xs, S, M, L, XL
Color: Black
Composition: 87 % Nylon, 13 % Elastane
SKU: OB-060-1300



KINGSBOX RISING FROM THE WEAK T-SHIRT

Size: Xs, S, M, L, XL, XXL
Color: Black
Composition: 100% Cotton
SKU: OB-010-8200-



WOMENS CROP TANK TOP

Size: Xs, S, M, L, XL, XXL
Color: Black
Composition: 100% Cotton
SKU: OB-040-1301



WOMENS CROP TANK TOP

Size: Xs, S, M, L, XL, XXL
Color: Black
Composition: 100% Cotton
SKU: OB-040-1301



ROYAL DIGITAL CROWN T-SHIRT

Size: S, M, L, XL
Color: Black, Gray
Composition: 100% Cotton
SKU: OB-010-7200, OB-010-7210

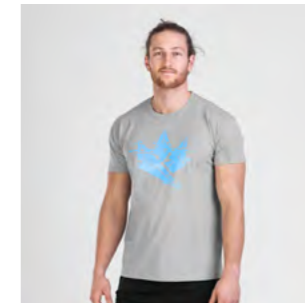



ROYAL FIRST SECOND T-SHIRT

Size: Xs, S, M, L, XL
Color: Black, Gray
Composition: 100% Cotton
SKU: OB-010-7100, OB-010-7110



ROYAL INNOVATION T-SHIRT

Size: S, M, L, XL, XXL
Color: Black, White
Composition: 100% Cotton
SKU: OB-010-7000



KINGSBOX SNATCH FACE T-SHIRT

Size: Xs, S, M, L, XL, XXL
Color: Black
Composition: 100% Cotton
SKU: OB-010-8300



WOMENS CROP TANK TOP

Size: Xs, S, M, L, XL
Color: Black/Gray
Composition: 100% Cotton
SKU: OB-010-8300



KINGSBOX MANS TRAINING PANTS 2.0

Size: M, L, XL, XXL, XXXL
Color: Black
Composition: 25 % Polyester, 25 % Spandex
SKU: OB-080-1102



KINGSBOX MANS TRAINING SHORTS 2.0

Size: M, L, XL, XXL, XXXL
Color: Black
Composition: 80 % Nylon, 20 % Spandex
SKU: OB-080-1302



KINGSBOX MANS WORKOUT SHORTS

Size: Xs, S, M, L, XL
Color: Gray
Composition: 100% Polyester
SKU: OB-080-1402



Hoody

Size: Xs, S, M, L, XL
Color: Gray
SKU: OB-040-1301



CUSTOM APPAREL

DO YOU NEED CUSTOM CLOTHING FOR YOUR GYM?

WE CAN PRINT CUSTOM CLOTHING FOR YOU.

CONTACT US!

CUSTOMER SERVICE

MO - FRI 8:00 - 16:00

Telephone:
+386 30 351 866

E-mail:
info@kingsbox.it

OTHER APPAREL



01 KingsBox Classic SnapBack Cap | Black/Black, Black/White | Article no: OB-100-1002, OB-100-1001
 • 02 KingsBox Blacknight Water Bottle | Article no: X-097-9002
 • 03 KingsBox Patches | Article no: X-097-6010
 • 04 KingsBox Backpack | black, green | Article no: KX-093-3000
 • 05 KingsBox Bold sport backpack | black,green | 35L | Article no: X-093-3100
 • 07 Kings-Box Keychain | Article no: X-097- 8100



KIDS EQUIPMENT

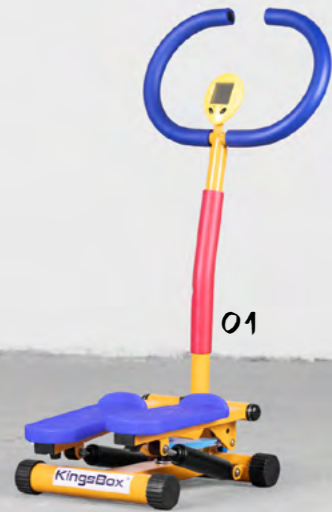

01

01 KingsBox Kids Stepper
| Article no: X-104-1040 · 02
KingsBox Kids Runner |
Article no: X-104-1021 · 03
KingsBox Kids Home Gym
Set | Article no: X-104-1020
· 04 KingsBox Kids Horse
Ride Simulator | Article no:
X-104-1000 · 05 KingsBox
Kids Bike | Article no:
X-104-1010 · 06 KingsBox
Kids Weightlifting Set |
Article no: X-104-1030 · 07
KingsBox Kids Dumbbells |
Article no: X-104-1050



02



03



04



05

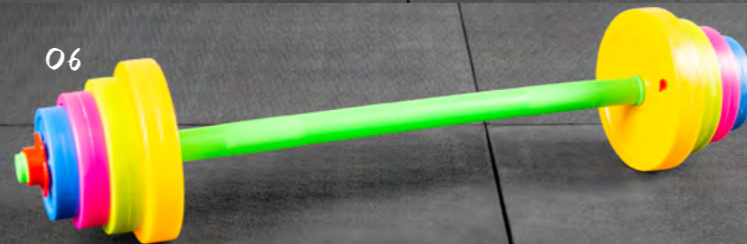

06



07



GYM DESIGN AND SPECIAL PRICES

We schedule a call with you. You tell us your wishes and desires, and we deliver a 3D drawing of your future gym. If your order exceeds 4000€ you will also get a very special discounted pricelist.

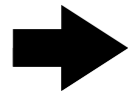

MADE IN EU

After we agree on all the details, we put the products in production. If requested, we offer also leasing financing.

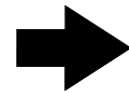

SHIPPING WITHIN 72H

For all orders above 1990€, the shipping costs are on us! The products are ready for shipping, usually within 24-72h, while 90% of all our products are usually in stock. The waiting time for custom made products extends to 4-6 weeks, after the confirmation and received 30% prepayment of the order.

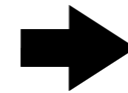

ENJOY YOUR NEW GYM

Even after the purchase, our customer support team is always at your disposal. All our products have at least a two-year warranty, some even a lifetime warranty.

PUBLISHER :

TNG Oprema d.o.o.
Bazoviška cesta 7a
6210 Sežana
info@kingsbox.com

CREATIVE DIRECTION

Visual Studio KingsBox
Erik Emersic

PHOTOGRAPHY

Visual Studio KingsBox
Erik Emersic

We reserve the rights to change print and typing errors after printing. For KingsBox Terms & Conditions visit <https://www.kingsbox.it/en/for-the-user/termini-condizioni/>

CUSTOMER SERVICE

MO - FRI 8:00 - 16:00

Telephone:

+386 30 351 866

E-mail:

info@kingsbox.it



Visit us on **facebook** at facebook.com/kingsbox



Visit us on **instagram** at [@kingsbox](https://instagram.com/kingsbox)

